



EX-TRAFIRE[®]

PLASMA CUTTING SYSTEMS CATALOG



THERMACUT™ - THE CUTTING COMPANY

FROM THE GARAGE TO THE SHIPYARD

"A successful product begins with a simple idea". The idea was to create a plasma cutting power supply. Criteria were set precisely. It has to be powerful, versatile, easy to operate, durable and portable.

AND WE CREATED IT.
IT'S CALLED
THE **EX-TRAFIRE**®

EX-TRAFIRE® PLASMA SYSTEMS

TABLE OF CONTENTS

OVERVIEW

EX-TRAFIRE® SD LINE	4-5
----------------------------	-----

EX-TRAFIRE® 30H

System SPECIFICATION	6-11
FHT-EX®30H PLASMA TORCH	12-15

EX-TRAFIRE® 40SD

System SPECIFICATION	16-21
FHT-EX®40H/M PLASMA TORCH	22-27

EX-TRAFIRE® 45SD

System SPECIFICATION	28-33
FHT-EX®45TT H/M PLASMA TORCH	34-39

EX-TRAFIRE® 55SD

System SPECIFICATION	40-45
-----------------------------	-------

EX-TRAFIRE® 75SD

System SPECIFICATION	46-51
-----------------------------	-------

EX-TRAFIRE® 100SD

System SPECIFICATION	52-59
-----------------------------	-------

FHT-EX® 105RTX PLASMA TORCH

Hand Torch SPECIFICATION	60-63
Machine Torch SPECIFICATION	64-67

ACCESSORIES

EX-TRAFIRE® ACCESSORIES	68-69
--------------------------------	-------

EX-TRAFIRE® SD LINE OVERVIEW

Features / System	EX-TRAFIRE® 30H	EX-TRAFIRE® 40SD	EX-TRAFIRE® 45SD
Cutting current [I2]	10 - 30A	10 - 40A	10 - 30A
Input voltage [I2]	CE 220-240 VAC ± 15 %	CE 1 x 230VAC ± 15 %	1 x 120VAC ± 15 %
Duty cycle	35%@30A-92V 60%@25A-90V 100%@21A-88,4V	40%@40A-120V 60%@30A-140V 100%@25A-140V	35%@30A-92V 60%@26A-90,4V 100%@21A-88,4V
I1 max	22A	26A	28,8A
I1 eff	13A	16,4A	17A
Weight [kg]	10,5	11,8	12,7
Width [mm]	165	177	177
Depth [mm]	480	467	467
Height [mm]	290	228	228
Industry (IOT) 4.0			
Handheld Application	Yes	Yes	Yes
Mechanised Application	Not applicable	Optional, Yes	Optional, Yes
Gouging	Not recommended	Possible	Possible
Grid Cutting	Yes	Yes	Yes
Torch	FHT-EX®30H	FHT-EX®40	FHT-EX®45TT
Information's	48l/min @4,5bar dynamic	120l/min @4,5bar dynamic	90l/min @4,5bar dynamic
Recommended Cut	(*) 8mm	(*) 12mm	(*) 8mm
Maximum	(*) 10mm	(*) 20mm	(*) 10mm
Piercing	(*) 8mm	(*) 8mm	(*) 8mm
Recommended Cut	(**) 4mm	(**) 4mm	(**) 4mm
Maximum	(**) 8mm	(**) 8mm	(**) 8mm
Piercing	(**) 4mm	(**) 4mm	(**) 4mm
Recommended Cut	(***) 6mm	(***) 6mm	(***) 6mm
Maximum	(***) 10mm	(***) 10mm	(***) 10mm
Piercing	(***) 6mm	(***) 6mm	(***) 6mm
Gas type	Compressed Air		
Gas quality	Recommended Air quality: ISO 8573-1 Class 1.2.2.		
Air specification	Air max. particle size: 0.1 microns, class 1 ref. to ISO 8573, Air max. oil: 0.1 mg / m3, class 2 ref.: ISO 8573, Air max. dew point: +3° C, class 4 ref. to ISO 8573		
Nitrogen	Purity ≥ 99,99%		
Gas quality	Clean, moisture-free, without oil		
	(*) Recommendation up to based on low alloyed steel handheld cutting starting from the edge (up to)		
	(**) Recommendation up to based SST handheld cutting starting from the edge (up to)		
	(***) Recommendation up to based on Aluminium handheld cutting starting from the edge (up to)		

	EX-TRAFIRE® 55SD		EX-TRAFIRE® 75SD		EX-TRAFIRE® 100SD
	30 - 55A		30 - 75A		30 - 100A
± 15 %	CE 3 x 400VAC ± 15 %	3 x 220VAC ± 15 %	CE 3 x 400VAC ± 15 %	3 x 220VAC ± 15 %	3x400 VAC ± 15 %
100%@40A	50%@55A-170V 60%@50A-170V 100%@41A-170V	60%@55A-140V 100%@42A-140V	100%@75A-170V		50%@100A-170V 60%@91A-170V 100%@80A-170V
	14,9A	28,9A	21,6A	38,6A	29,6A
	10,5A	22,3A	21,6A	38,6A	20,7A
	11,8		24		24
	177		265		265
	467		560		560
	229		400		400
	Not applicable				
	Yes		Yes		Yes
	Optional, Yes		Optional, Yes		Optional, Yes
	Yes		Yes		Yes
	Yes		Yes		Yes
	FHT-EX®105RTX				
	105A/100A approx. 135 l/min, 85A/75A approx. 110 l/min, 65A /55A approx. 98 l/min, 45A approx. 87l/min				
n	(*) 20mm		(*) 25mm		(*) 35mm
n	(*) 30mm		(*) 35mm		(*) 50mm
n	(*) 20mm		(*) 20mm		(*) 20mm
m	(**) 15mm		(**) 18mm		(**) 20mm
m	(**) 25mm		(**) 25mm		(**) 38mm
m	(**) 16mm		(**) 20mm		(**) 20mm
m	(***) 15mm		(***) 18mm		(***) 20mm
m	(***) 25mm		(***) 25mm		(***) 35mm
m	(***) 16mm		(***) 20mm		(***) 20mm

EX-TRA[®]FIRE 30H

**PORTABLE AND POWERFUL
PLASMA CUTTING SYSTEM**



EX-TRAFIRE® 30H



SIMPLE OPERATION



- + Plug & cut
- + Easily accessible filter regulator Engineered for professionals and metal artists

EX-TRA PERFORMANCE



- + Cutting
- + Precise cuts
- + Easy operation

HIGHEST APPLICATION FLEXIBILITY



- + Plate thicknesses up to 10 mm +
- + Lightweight, exceptionally portable
- + Fixed torch with flexible torch package

BEST COST-EFFECTIVENESS



- + Very low investment
- + Lower running costs

EX-TRAFIRE® 30H

SPECIFICATIONS

- AMPS (A)** 10-30
- INPUT VOLTAGE (VAC)** 220-240V ± 15 %
- PLASMA GAS** COMPRESSED AIR
- CERTIFICATION** CE, C-TICK, CCC
- MODES** CUTTING
- FREQUENCY (Hz)** 50/60
- MAXIMUM INPUT POWER (kVA)** 4.9
- OUTPUT VOLTAGE (VDC)** 92
- DUTY CYCLE @ 40 °C** 35% @ 30A, 100% @ 21A
- DIMENSION (L x H x W) MM** 480x290x165
- WEIGHT (KG)** 10.5
- RECOMMENDED CUTTING CAPACITY (MM)** 8
- SEVERANCE CUTTING CAPACITY (MM)** 10
- PIERCING CUTTING CAPACITY (MM)** 8
- AIR FLOW @ (LPM/BAR)** 48 @ 4.5
- MAXIMUM INPUT PRESSURE (BAR/PSI)** 10/145
- PROTECTION LEVEL** IP23S
- INSULATION CLASS** H/F
- CNC INTERFACE** NO
- INDUSTRY 4.0** NO
- TYPE OF HAND TORCH** FHT-EX®30H

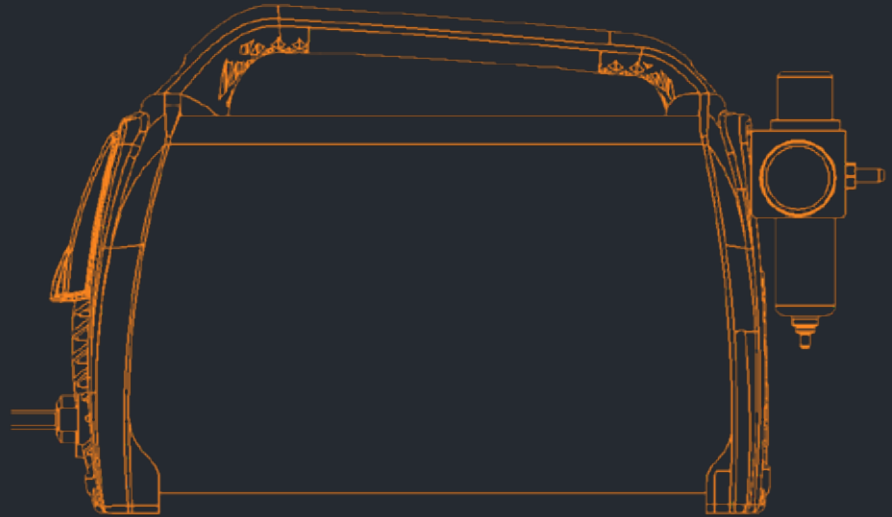

MILD STEEL CUTTING CAPACITY IN MILLIMETRES

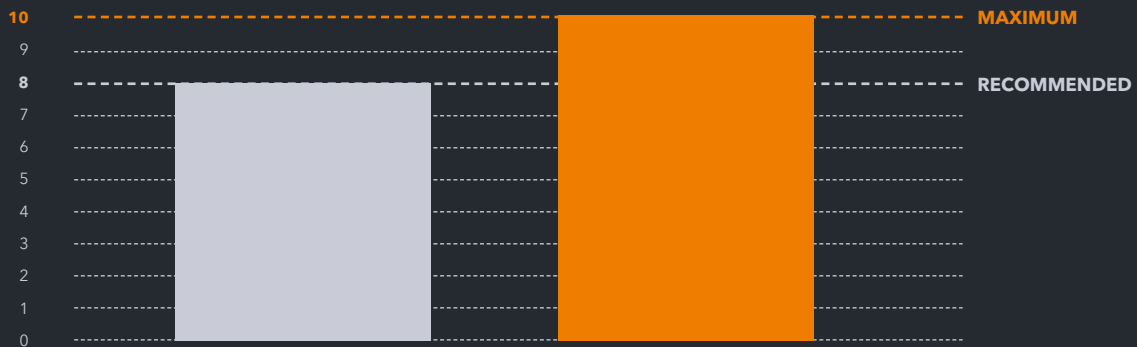

COMPARISON WITH COMPETITIVE PLASMA CUTTING MACHINES

EX-TRAFIRE® 30H IS THE MOST LIGHTWEIGHT IN ITS CLASS (INCLUDING TORCH AND WORK CABLE)



EX-TRAFIRE® 30H

ORDERING INFORMATION

Description	Length	Part No.
MANUAL PLASMA CUTTING SYSTEMS		
EX-TRAFIRE®30H/CE/1x220-240VAC Hand System/ FHT-EX30H-FC 4m/H Starter Kit	4m	EX-1-010-005

AVAILABLE BULK PACKS

Description	Pcs	Part No.
Bulk Pack - Electrode - 25pcs	1	EX-2-434-014
Bulk Pack - Nozzle 30A 0.8mm - 25pcs	1	EX-2-435-015
Bulk Pack - Hand (Contact) Shield 30A - 18pcs	1	EX-2-436-016
Bulk Pack - Machine Shield 30A - 18pcs	1	EX-2-437-017

ACCESSORIES

Description	STD Package QTY	Part No.
DN 7.2 ES Quick Connect Plug with male thread G 1/4"	1	EX-0-802-001
DN 7.2 ES Quick Connect Coupling with male thread G 1/4"	1	EX-0-802-002
Grease 25ml	1	EX-0-805-001
Filter-EX Compressed Air Filter	1	EX-0-804-001
Filter-EX Air Filter Cartridge	8	EX-0-804-002
Circle cutting guide kit for FHT-EX®30/40H	1	EX-2-801-001

EX-TRAFIRE® 30H



FRONT VIEW



BACK VIEW



SIDE VIEW

FHT-EX® 30H



**LIGHTWEIGHT
POWERFUL**



The extra-lightweight FHT-EX®30H handheld torch with a flexible cable is suitable for a wide range of applications and ideal for mobile use. This torch is optimally designed for use with EX-TRAFIRE® 30H power supplies. It is permanently connected to the power supply and provides precise cutting results on plate thicknesses of up to 10 mm and more.

This particularly cost-effective entry-level torch is the result of decades of experience in the field of plasma cutting. It features a robust and durable design in which all consumables can be replaced quickly and easily.

BENEFITS

- An ergonomically shaped handheld torch that reduces fatigue
- Compact and particularly flexible for handheld applications, even if difficult to reach
- A long lifetime thanks to a 100% duty cycle at 21A
- Ideal for plate thicknesses of up to 10 mm and more with high power reserves
- Consumables with an extended lifetime
- Optimal heat dissipation thanks to a screw-on electrode
- Piercing max. 8 mm
- Specially designed for use with the EX-TRAFIRE®30H power supply

HAND TORCH ASSEMBLY

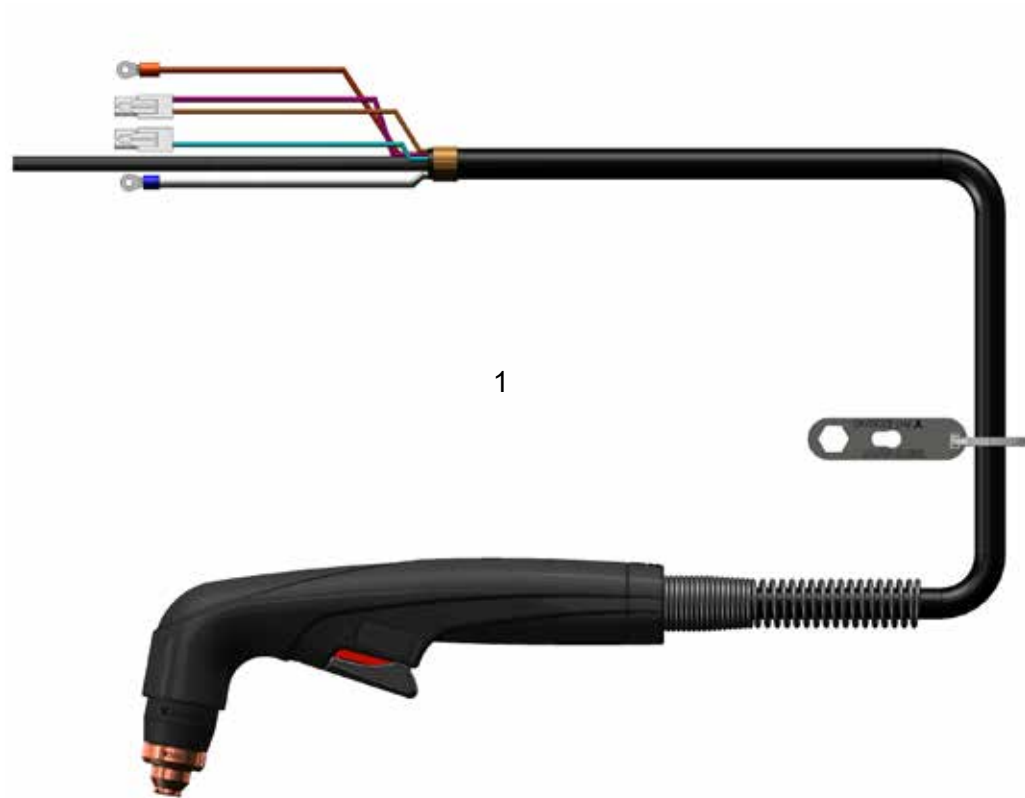

Item	Part No.	Description	Pcs.
1.	EX-1-134-001	FHT-EX®30H Hand Torch Assembly with 4m Lead/FC	1

FHT-EX® 30H

HAND TORCH COMPONENTS

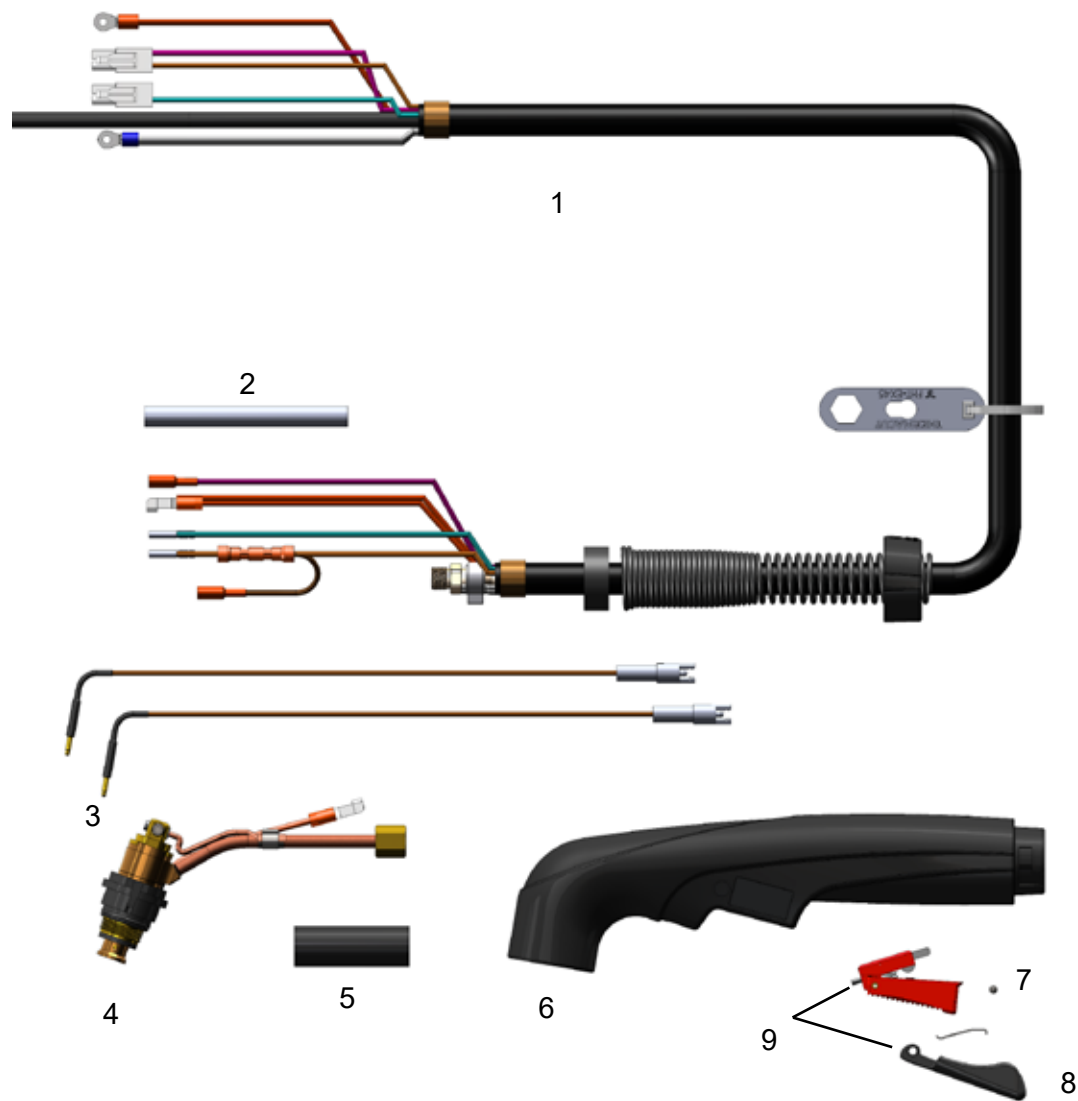

Item	Part No.	Description	Pcs.	Item	Part No.	Description	Pcs.
1.	EX-1-373-001	Hand Torch Lead Replacement Kit 4m Lead/FC	1	6.	EX-2-314-015	Hand Torch Handle Replacement Kit	1
2.	EX-0-319-021	Insulating Teflon Tube	1	7.	EX-5-309-013	Trigger	1
3.	EX-2-304-020	Hand Torch PIP Pins Replacement Kit (with Wires)	1	8.	EX-5-310-014	Trigger Guard	1
4.	EX-2-302-009	Hand Torch Body FHT-EX®30H	1	9.	EX-5-313-018	Safety Trigger Replacement Kit	1
5.	EX-0-319-011	Shrink Tube	1	NS	EX-2-431-014	O-Ring (fitted on the torch body)	2

CONSUMABLES

HAND TORCH CONSUMABLES

HAND
30A SHIELDED
CONFIGURATION
MACHINE

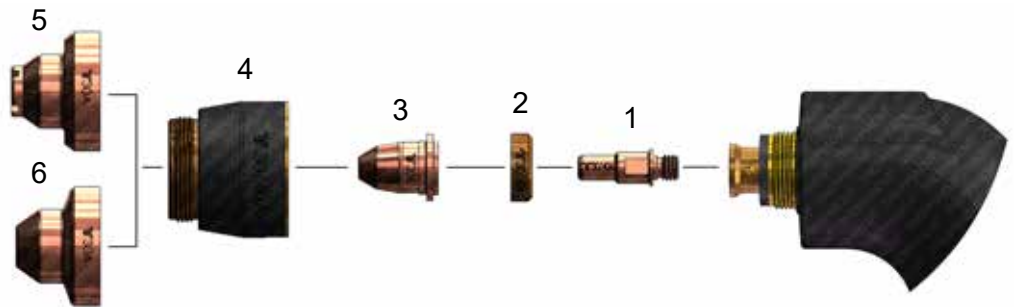

Item	Part No.	Description	Pcs	Item	Part No.	Description	Pcs
1.	EX-2-401-001	Electrode	5	⊕ 6.	EX-2-421-006	Machine Shield 30A	1
2.	EX-2-404-002	Swirl Ring	2	NS	EX-2-434-014	Bulk Pack - Electrode - 25pcs	1
3.	EX-2-409-003	Nozzle 30A 0.8mm	5	NS	EX-2-435-015	Bulk Pack - Nozzle 30A 0.8mm - 25pcs	1
4.	EX-2-415-004	Nozzle Retaining Cap (Protection Cap)	1	NS	EX-2-437-017	Bulk Pack - Machine Shield 30A - 18pcs	1
5.	EX-2-419-005	Hand Shield 30A	1				

NS NOT SHOWN IN THE PICTURE

⊕ **FOR USE WITH CIRCLE CUTTING GUIDE OR FOR BEVEL CUTTING**

EX-TRA[®]FIRE^{40SD}

**LIGHTWEIGHT AND POWERFUL
PLASMA CUTTING SYSTEM**



EX-TRAFIRE® 40SD



CUTTING
40A
CURRENT

MATERIAL
15+^m
THICKNESS

WEIGHT
11,8
KILOGRAMS

SIMPLE OPERATION



- + Plug & cut
- + Engineered for hobbyist

HIGHEST APPLICATION FLEXIBILITY



- + Plate thicknesses up to 15 mm +
- + Lightweight, exceptionally portable

EX-TRA PERFORMANCE



- + Precise cuts
- + Easy operation

BEST COST-EFFECTIVENESS

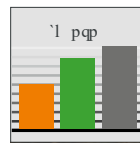

- + Very low investment
- + Lower running costs

EX-TRAFIRE® 40SD

SPECIFICATIONS

- AMPS (A)** 10-30 A (120 VAC) / 10-40 A (230 VAC)
- INPUT VOLTAGE (VAC)** 100/240 VAC ± 15 %
- PLASMA GAS** COMPRESSED AIR
- CERTIFICATION** CE, C-TICK, CCC
- MODES** CUTTING / GRID CUTTING
- FREQUENCY (Hz)** 50/60
- MAXIMUM INPUT POWER (kVA)** 3.45 kVA @ 120 VAC / 5.98 kVA @ 230 VAC
- OUTPUT VOLTAGE (VDC)** 140
- DUTY CYCLE @ 40 °C** 40 % @ 40 A, 100 % @ 25 A
- DIMENSION (L × H × W) MM** 469×228×177
- WEIGHT (KG)** 11.8
- RECOMMENDED CUTTING CAPACITY (MM)** 12
- SEVERANCE CUTTING CAPACITY (MM)** 20
- PIERCING CUTTING CAPACITY (MM)** 8
- AIR FLOW @ (LPM/BAR)** 120 @ 4.5
- MAXIMUM INPUT PRESSURE (BAR/PSI)** 10/145
- PROTECTION LEVEL** IP23S
- INSULATION CLASS** H/F
- CNC INTERFACE** YES
- INDUSTRY 4.0** NO
- TYPE OF TORCH** FHT-EX®40H/M

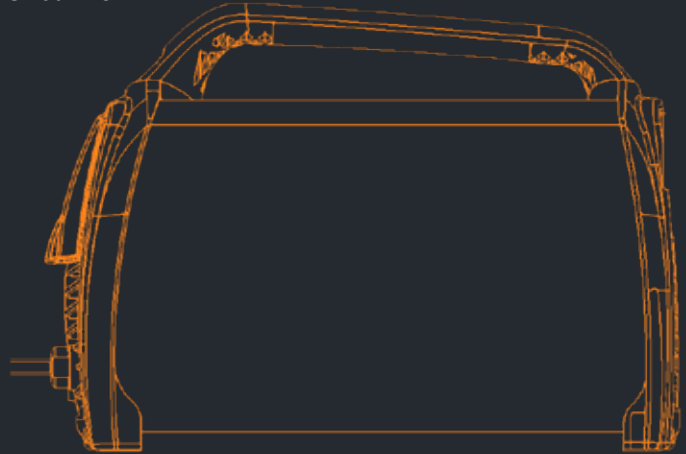

MILD STEEL CUTTING CAPACITY IN MILLIMETRES

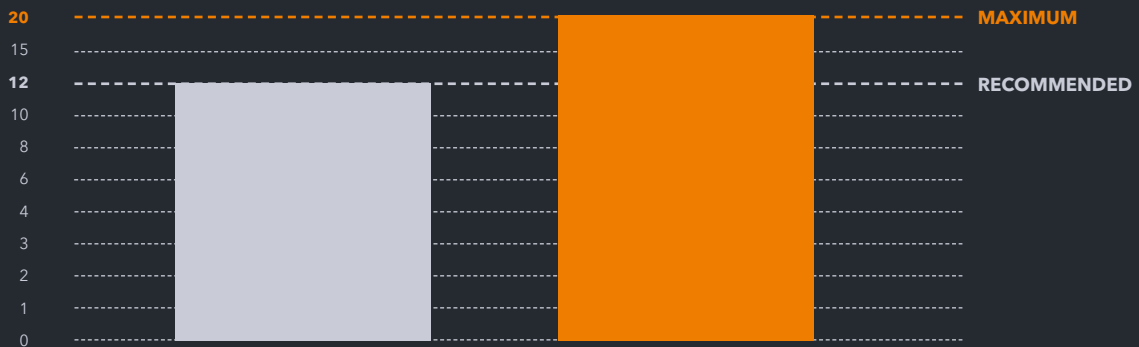

COMPARISON WITH COMPETITIVE PLASMA CUTTING MACHINES

EX-TRAFIRE®40SD IS THE MOST POWERFUL SYSTEM IN IT'S CLASS.



EX-TRAFIRE® 40SD

ORDERING INFORMATION

Description	Length	Part No.
MANUAL PLASMA CUTTING SYSTEMS		
EX-TRAFIRE®40SD/CE/1x100-240V Hand System/FHT-EX40H 4m/H Starter Kit	4m	EX-2-010-001
EX-TRAFIRE®40SD/CE/1x100-240V Hand System/FHT-EX40H 5m/H Starter Kit	5m	EX-2-010-002
EX-TRAFIRE®40SD/CE/1x100-240V Hand System/FHT-EX40H 7,5m/H Starter Kit	7.5m	EX-2-010-003
EX-TRAFIRE®40SD/CE/1x100-240V Hand System/FHT-EX40H 15m/H Starter Kit	15m	EX-2-010-004
MECHANIZED PLASMA CUTTING SYSTEMS		
EX-TRAFIRE®40SD/CE/1x100-240V Machine System/FHT-EX40M 4m/M Starter Kit	4m	EX-2-011-001
EX-TRAFIRE®40SD/CE/1x100-240V Machine System/FHT-EX40M 5m/M Starter Kit	5m	EX-2-011-002
EX-TRAFIRE®40SD/CE/1x100-240V Machine System/FHT-EX40M 7,5m/M Starter Kit	7.5m	EX-2-011-003
EX-TRAFIRE®40SD/CE/1x100-240V Machine System/FHT-EX40M 15m/M Starter Kit	15m	EX-2-011-004
PLASMA POWER SUPPLY UNITS		
EX-TRAFIRE®40SD/CE/1x100-240V power supply unit (fully-equipped)		EX-2-001-007

AVAILABLE BULK PACKS

Description	Pcs	Part No.
Bulk Pack - Electrode - 25pcs	1	EX-2-434-014
Bulk Pack - Nozzle 30A - 25pcs	1	EX-2-435-015
Bulk Pack - Hand (contact) Shield 30A - 18pcs	1	EX-2-436-016
Bulk Pack - Machine Shield 30A - 18pcs	1	EX-2-437-017
Bulk Pack - Nozzle 40A - 25pcs	1	EX-2-435-001
Bulk Pack - Hand (contact) Shield 40A - 18pcs	1	EX-2-436-001
Bulk Pack - Machine Shield 40A - 18pcs	1	EX-2-437-001

ACCESSORIES

Description	Pcs	Part No.
DN 7.2 ES Quick Connect Plug with female thread G 1/4"	1	EX-0-802-000
DN 7.2 ES Quick Connect Plug with male thread G 1/4"	1	EX-0-802-001
DN 7.2 ES Quick Connect Coupling with male thread G 1/4"	1	EX-0-802-002
Grease 25ml	1	EX-0-805-001
Filter-EX Compressed Air Filter	1	EX-0-804-001
Filter-EX Air Filter Cartridge	8	EX-0-804-002
Circle cutting guide kit for FHT-EX®30/40H	1	EX-2-801-001

EX-TRAFIRE® 40SD



FRONT VIEW



BACK VIEW



SIDE VIEW

FHT-EX® 40H

HAND TORCH ASSEMBLY



Item	Part No.	Description	Pcs
1.	EX-2-133-000	DEMO FHT-EX®40H Hand Torch Assembly/TCS13	1
	EX-2-130-001	FHT-EX®40H Hand Torch Assembly w/o consumables/4m Lead/TCS13	1
	EX-2-101-003	FHT-EX®40H Hand Torch Assembly w/o consumables/5m Lead/TCS13	1
	EX-2-131-005	FHT-EX®40H Hand Torch Assembly w/o consumables/7.5m Lead/TCS13	1
	EX-2-106-007	FHT-EX®40H Hand Torch Assembly w/o consumables/15m Lead/TCS13	1
⊕ 2.	EX-0-321-003	Latch with Key Assembly	1

⊕ LATCH WITH KEY IS NOT CONTENT OF TORCHES ABOVE. IF YOU NEED IT, YOU HAVE TO ORDER SEPARATELY.

FHT-EX® 40H

HAND TORCH COMPONENTS

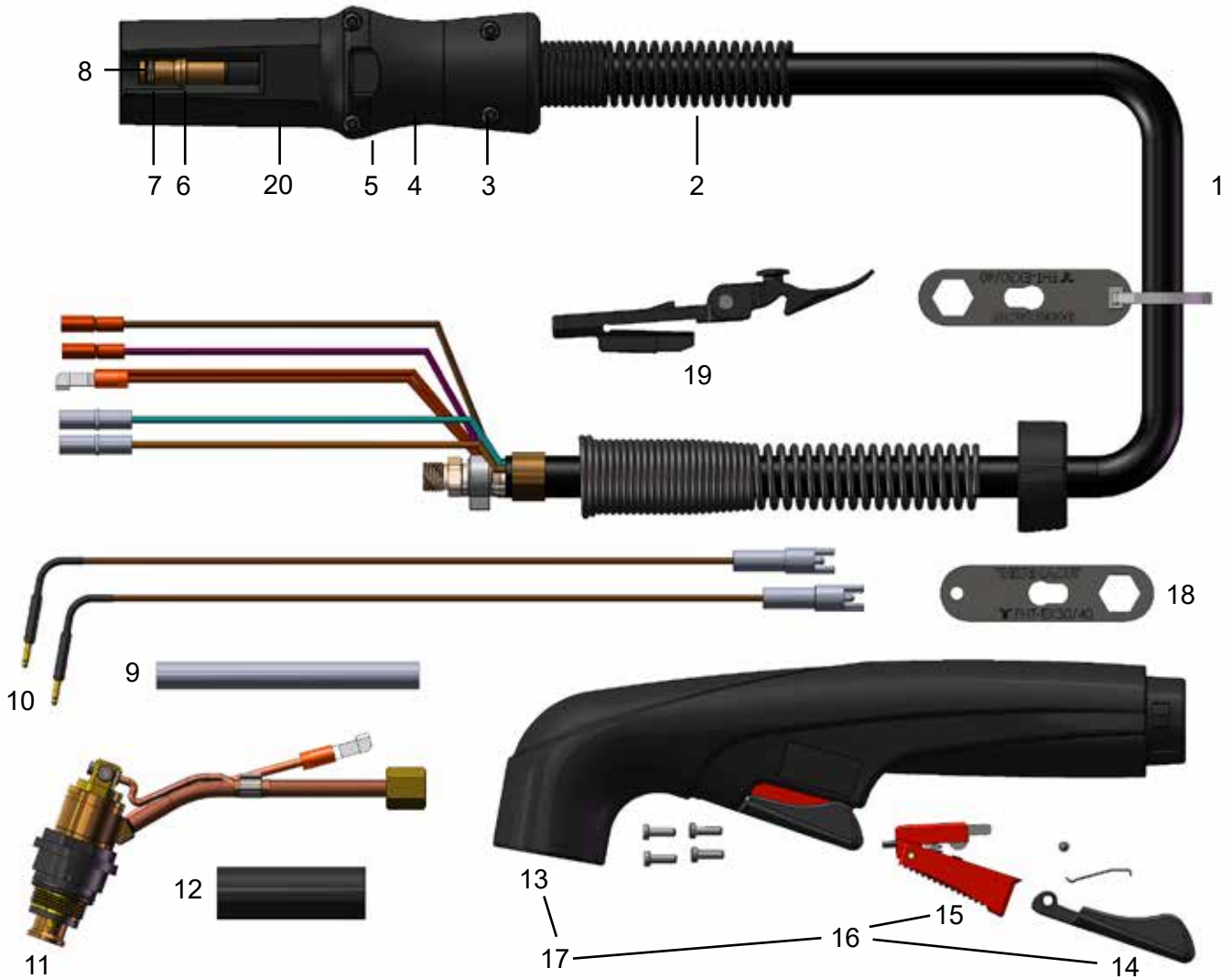

Item	Part No.	Description	Pcs	Item	Part No.	Description	Pcs
1.	EX-2-328-001	Hand Torch Lead Replacement Kit 4m Lead/TCS13	1	10.	EX-2-304-020	Hand Torch PIP Pins Replacement Kit (with Wires)	1
	EX-2-331-002	Hand Torch Lead Replacement Kit 5m Lead/TCS13	1	11.	EX-2-302-009	Hand Torch Body FHT-EX®40H	1
	EX-2-329-003	Hand Torch Lead Replacement Kit 7.5m Lead/TCS13	1	12.	EX-0-319-011	Shrink Tube	1
	EX-2-336-004	Hand Torch Lead Replacement Kit 15m Lead/TCS13	1	13.	EX-2-308-012	Hand Torch Handle Kit	1
2.	EX-5-318-001	TCS Plug Spring Strain Relief	1	14.	EX-5-310-014	Trigger Guard	1
3.	EX-0-325-015	TCS Clam Shell Screw	1	15.	EX-5-309-013	Trigger	1
4.	EX-0-325-002	TCS Clam Shell Upper	1	16.	EX-5-313-018	Safety Trigger Replacement Kit	1
5.	EX-0-325-001	TCS Clam Shell Lower	1	17.	EX-2-314-015	Hand Torch Handle Replacement Kit	1
6.	EX-0-325-010	Retaining Ring (Outer circlip ring)	1	18.	EX-2-427-010	Electrode Wrench FHT-EX®30/40	1
7.	EX-0-325-009	O-Ring (fitted in the TCS plug)	1	19.	EX-0-321-003	Latch with Key Assembly	1
8.	EX-0-325-005	Male Crimp Pin for TCS Plug	1	20.	EX-0-323-001	TCS13 Plug Body	1
9.	EX-0-319-021	Insulating Teflon Tube	1	NS	EX-2-431-014	O-Ring (fitted on the torch body)	2

FHT-EX® 40M

MACHINE TORCH ASSEMBLY

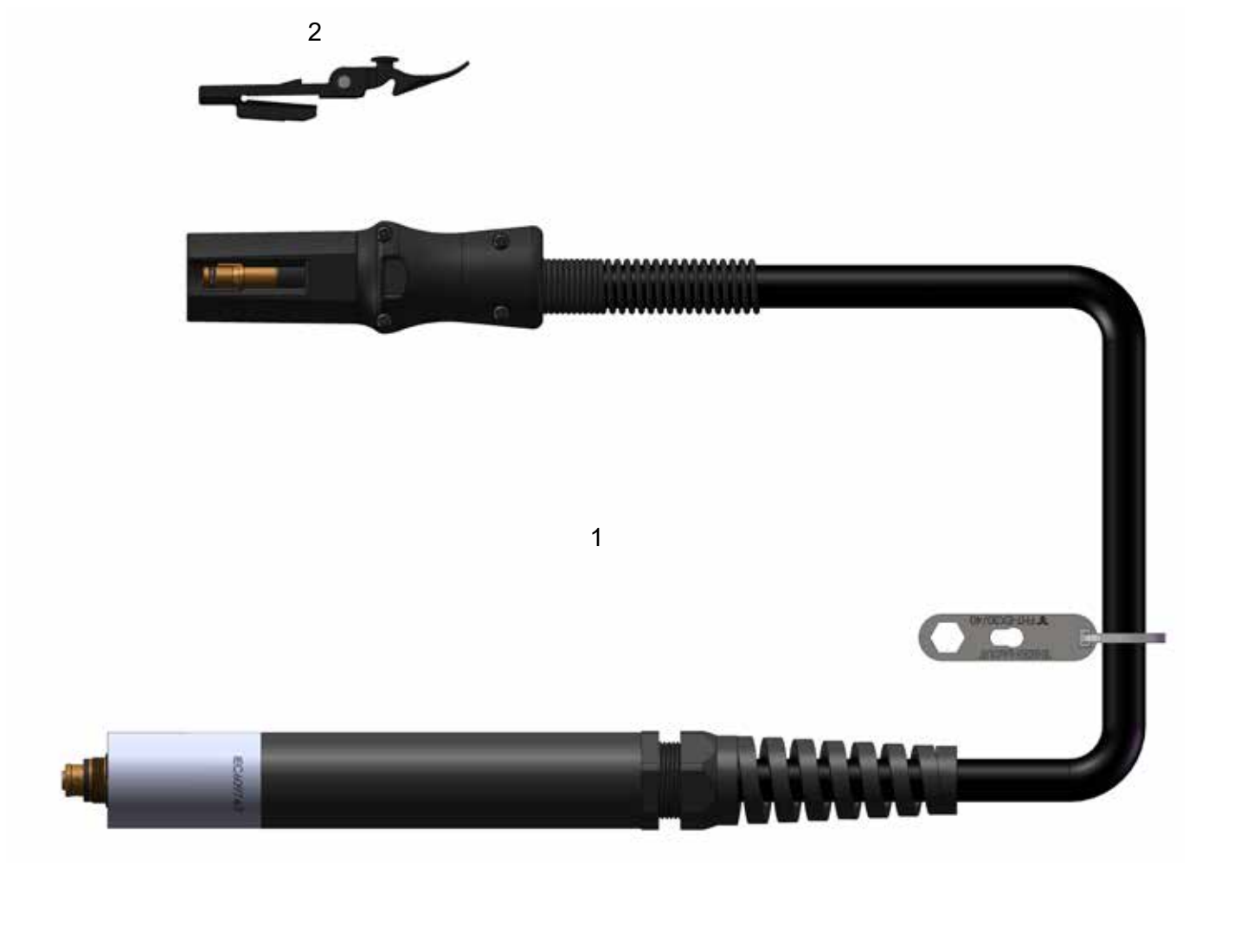

Item	Part No.	Description	Pcs
1.	EX-2-233-000	DEMO FHT-EX®40M Machine Torch Assembly / TCS13	1
	EX-2-235-001	FHT-EX®40M Machine Torch Assembly w/o consumables/4m Lead/TCS13	1
	EX-2-202-003	FHT-EX®40M Machine Torch Assembly w/o consumables/5m Lead/TCS13	1
	EX-2-236-005	FHT-EX®40M Machine Torch Assembly w/o consumables/7.5m Lead/TCS13	1
	EX-2-207-007	FHT-EX®40M Machine Torch Assembly w/o consumables/15m Lead/TCS13	1
⊕ 2.	EX-0-321-003	Latch with Key Assembly	1

⊕ LATCH WITH KEY IS NOT CONTENT OF TORCHES ABOVE. IF YOU NEED IT, YOU HAVE TO ORDER SEPARATELY.

FHT-EX® 40M

MACHINE TORCH COMPONENTS

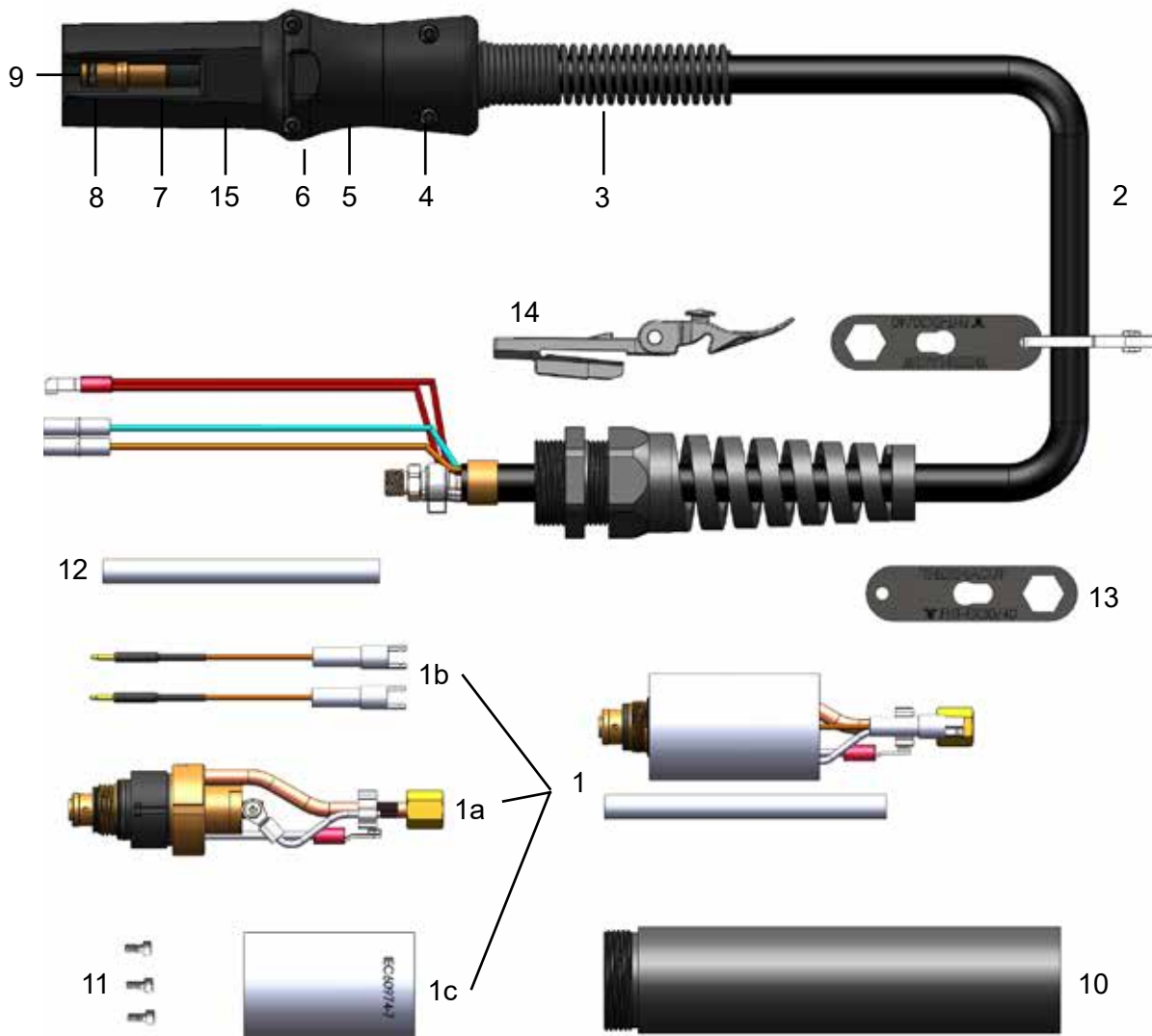

Item	Part No.	Description	Pcs	Item	Part No.	Description	Pcs
1.	EX-2-301-010	Machine Torch Body Assembly FHT-EX®40M	1	6.	EX-0-325-001	TCS Clam Shell Lower	1
1a.	EX-2-301-011	Machine Torch Body FHT-EX®40M	1	7.	EX-0-325-010	Retaining Ring (Outer Circlip Ring)	1
1b.	EX-2-304-021	Machine Torch PIP Pins Replacement Kit (with Wires)	1	8.	EX-0-325-009	O-Ring (fitted in the TCS plug)	1
1c.	EX-2-306-022	Torch Mounting Sleeve (incl. screws)	1	9.	EX-0-325-005	Male Crimp Pin for TCS Plug	1
2.	EX-2-326-005	Machine Torch Lead Replacement Kit 4m Lead/TCS13	1	10.	EX-2-306-023	Torch Positioning Sleeve	1
	EX-2-352-006	Machine Torch Lead Replacement Kit 5m Lead/TCS13	1	11.	EX-0-372-001	Torch Mounting Screw	1
	EX-2-327-007	Machine Torch Lead Replacement Kit 7.5m Lead/TCS13	1	12.	EX-0-319-021	Insulating Teflon Tube	1
	EX-2-357-008	Machine Torch Lead Replacement Kit 15m Lead/TCS13	1	13.	EX-2-427-010	Electrode Wrench FHT-EX®40	1
3.	EX-5-318-001	TCS Plug Spring Strain Relief	1	14.	EX-0-321-003	Latch with Key Assembly	1
4.	EX-0-325-015	TCS Clam Shell Screw	1	15.	EX-0-323-001	TCS13 Plug Body	1
5.	EX-0-325-002	TCS Clam Shell Upper	1	NS	EX-2-431-014	O-Ring (fitted on the torch body)	2

CONSUMABLES

HAND / MACHINE TORCH CONSUMABLES

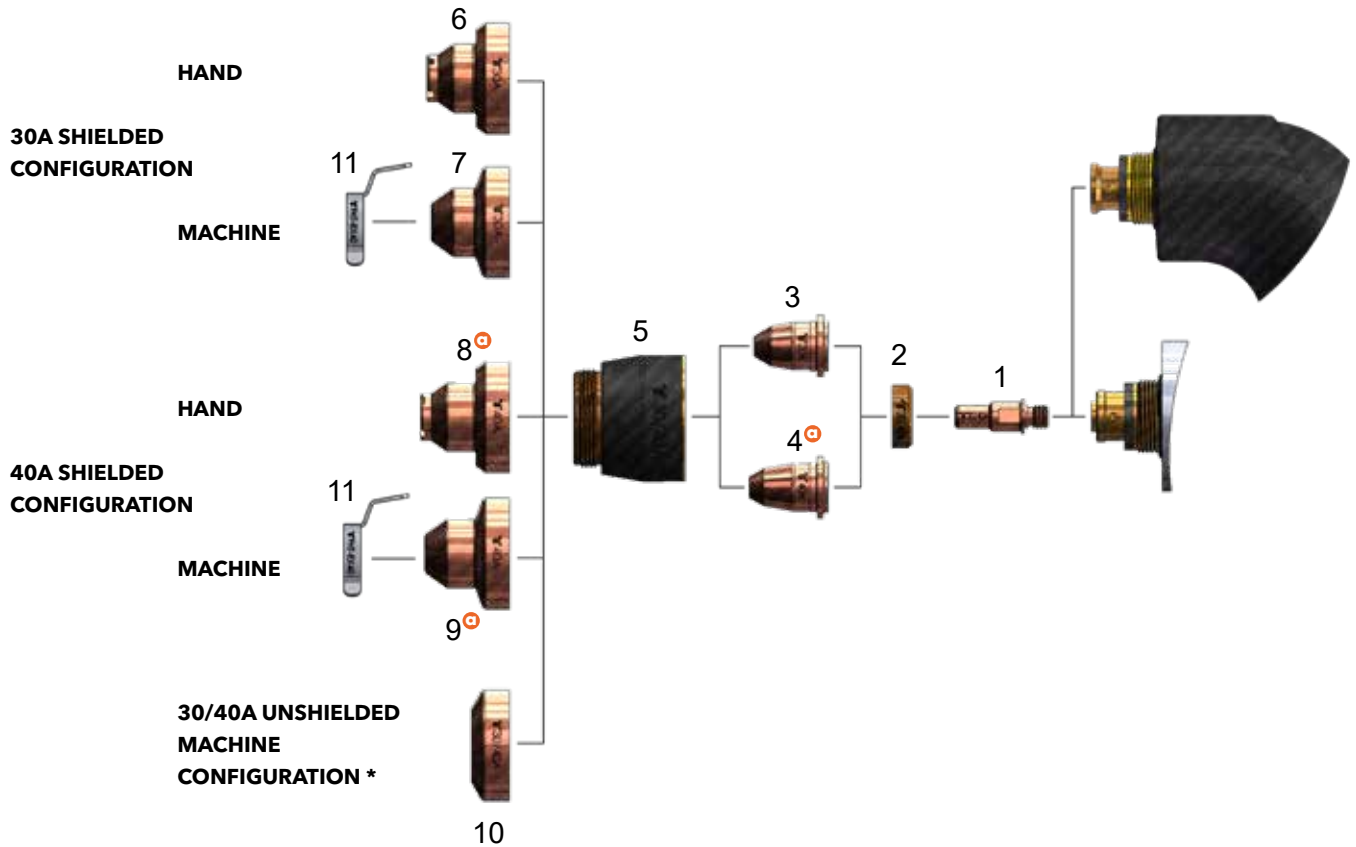

Item	Part No.	Description	Pcs	Item	Part No.	Description	Pcs
1.	EX-2-401-001	Electrode	5	9.	EX-2-421-001	Machine Shield 40A	1
2.	EX-2-404-002	Swirl Ring	2	10.	EX-2-423-107	Deflector	1
3.	EX-2-409-003	Nozzle 30A 0.8mm	5	NS	EX-2-434-014	Bulk Pack - Electrode - 25pcs	1
4.	EX-2-409-001	Nozzle 40A 0.9mm	5	NS	EX-2-435-015	Bulk Pack - Nozzle 30A 0.8mm - 25pcs	1
5.	EX-2-415-004	Nozzle Retaining Cap (Protection Cap)	1	NS	EX-2-435-001	Bulk Pack - Nozzle 40A 0.9mm - 25pcs	1
6.	EX-2-419-005	Hand Shield 30A	1	NS	EX-2-437-017	Bulk Pack - Machine Shield 30A - 18pcs	1
7.	EX-2-421-006	Machine Shield 30A	1	NS	EX-2-437-001	Bulk Pack - Machine Shield 40A - 18pcs	1
8.	EX-2-419-001	Hand Shield 40A	1	11.	EX-2-428-011	IHS Ohmic Clip	1

NS NOT SHOWN IN THE PICTURE

***** IN COUNTRIES FOLLOWING CE STANDARDS, UNSHIELDED CONSUMABLE CONFIGURATION MAY ONLY BE USED IN MECHANIZED TORCH APPLICATIONS.

⊕ **ONLY FOR EX-TRAFIRE®40SD**

EX-TRA[®]FIRE[®]45SD

**PROFESSIONAL AND VERSATILE
PLASMA CUTTING SYSTEM**

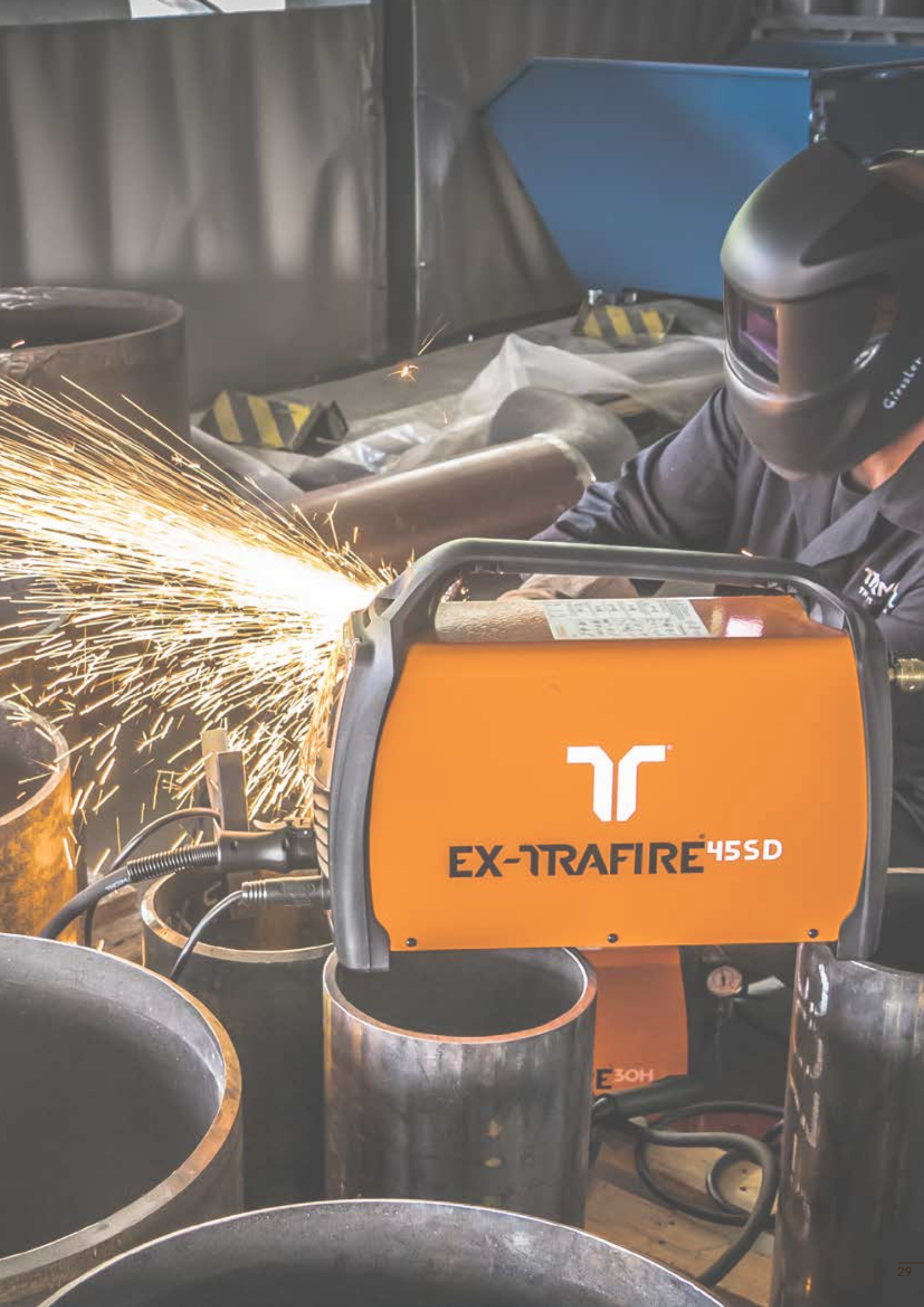

EX-TRAFIRE^{455D}

E30H

EX-TRAFIRE® 45SD



CUTTING
45A
CURRENT

MATERIAL
25+ mm
THICKNESS

CUTTING
6,5kW
OUTPUT

SIMPLE OPERATION



- + Bright LCD system information and control panel
- + Easily accessible, protected filter regulator
- + Engineered for professionals and demanding beginners

HIGHEST APPLICATION FLEXIBILITY



- + Plate thicknesses up to 25 mm +
- + Lightweight, exceptionally portable
- + TCS quick change flexible torch packages
- + Suitable for generator use

EX-TRA PERFORMANCE



- + Cutting, gouging, grid mode
- + Exact cuts
- + Industry leading blue LCD display

BEST COST-EFFECTIVENESS

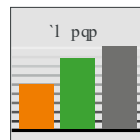

- + Significantly lower investment
- + High consumable lifetime
- + Lower running costs



EX-TRAFIRE® 45SD

SPECIFICATIONS

	SINGLE PHASE		THREE PHASE
Input voltage (VAC)	1x120V +-15%	1x230V +-15%	3x400V +-15%
Amps (A)	20-25	20-45	20-45
Plasma gas	Compressed air		
Certification CE, C-TICK, CCC	CE	CE/C-TICK	CE/C-TICK
Modes	CUTTING / GOUGING / GRID CUTTING		
Frequency (Hz)	50/60		
Maximum input power (kVA)	4,4	7,59	6,48
Output voltage (VDC)	145		
Duty cycle @ 40 °C	40%@25A / 100%@16A	50%@45A / 100%@32A	80%@45A / 100%40A
Dimension (L x H x W) MM	469 x 228 x 177		
Weight (KG)	12,7		
Recommended cutting capacity (MM)	8	12	
Severance cutting capacity (MM)	12	25	
Piercing cutting capacity (MM)	10	10	
Air flow @ (LPM/BAR)	90@4.8		
Maximum input pressure (BAR/PSI)	10/145		
Protection level	IP23S		
Insulation class	F		
CNC interface	YES		
Industry 4.0	NO		
Type of hand torch	FHT-EX®45TTH		
Type of machine torch	FHT-EX®45TTM		

MILD STEEL CUTTING CAPACITY IN MILLIMETRES



EX-TRAFIRE® 45SD

ORDERING INFORMATION

Description	Length	Part No.
MANUAL PLASMA CUTTING SYSTEMS		
EX-TRAFIRE®45SD/CE/3x400V Hand System/FHT-EX®45TTH 5m/H Starter Kit	5m	EX-2-010-011
EX-TRAFIRE®45SD/CE/3x400V Hand System/FHT-EX®45TTH 8m/H Starter Kit	8m	EX-2-010-012
EX-TRAFIRE®45SD/CE/3x400V Hand System/FHT-EX45®TTH 15m/H Starter Kit	15m	EX-2-010-013
EX-TRAFIRE®45SD/CE/1x110/230V Hand System/FHT-EX45®TTH 5m/H Starter Kit	5m	EX-2-010-020
EX-TRAFIRE®45SD/CE/1x110/230V Hand System/FHT-EX45®TTH 8m/H Starter Kit	8m	EX-2-010-021
EX-TRAFIRE®45SD/CE/1x110/230V Hand System/FHT-EX45®TTH 15m/H Starter Kit	15m	EX-2-010-022
MECHANIZED PLASMA CUTTING SYSTEMS		
EX-TRAFIRE®45SD/CE/3x400V Machine System/FHT-EX45®TTM 5m/M Starter Kit	5m	EX-2-011-008
EX-TRAFIRE®45SD/CE/3x400V Machine System/FHT-EX45®TTM 8m/M Starter Kit	8m	EX-2-011-009
EX-TRAFIRE®45SD/CE/3x400V Machine System/FHT-EX45®TTM 15m/M Starter Kit	15m	EX-2-011-010
EX-TRAFIRE®45SD/CE/1x110/230V Machine System/FHT-EX45®TTM 5m/M Starter Kit	5m	EX-2-011-014
EX-TRAFIRE®45SD/CE/1x110/230V Machine System/FHT-EX45®TTM 8m/M Starter Kit	8m	EX-2-011-015
EX-TRAFIRE®45SD/CE/1x110/230V Machine System/FHT-EX45®TTM 15m/M Starter Kit	15m	EX-2-011-016
PLASMA POWER SUPPLY UNITS		
EX-TRAFIRE®45SD/CE/3x400V power supply unit (fully-equipped)		EX-2-001-030
EX-TRAFIRE®45SD/CE/1x110/230V power supply unit (fully-equipped)		EX-2-001-024

AVAILABLE BULK PACKS

Description	Pcs	Part No.
Bulk Pack-Electrode - 25pcs	1	EX-2-434-201
Bulk Pack-Nozzle - 25pcs	1	EX-2-435-201
Bulk Pack - Hand (Contact) Shield - 18pcs	1	EX-2-436-201
Bulk Pack - Machine Shield - 18pcs	1	EX-2-437-201

ACCESSORIES

Description	Pcs	Part No.
DN 7.2 ES Quick Connect Plug with female thread G 1/4"	1	EX-0-802-000
DN 7.2 ES Quick Connect Plug with male thread G 1/4"	1	EX-0-802-001
DN 7.2 ES Quick Connect Coupling with male thread G 1/4"	1	EX-0-802-002
Grease 25ml	1	EX-0-805-001
Filter-EX Compressed Air Filter	1	EX-0-804-001
Filter-EX Air Filter Cartridge	8	EX-0-804-002

EX-TRAFIRE® 45SD



FRONT VIEW



BACK VIEW



SIDE VIEW

FHT-EX® 45TT



MODERN AND CAPABLE TORCH



The high-performant FHT-EX®45TT H/M hand and machine torches are ideal for meeting tough demands in continuous operation. These torches are optimally designed for use with EX-TRAFIRE® 45SD power supplies and are suitable for cutting, gouging and grid-cutting. They can cut plate thickness of up to 25 mm and more precisely and quickly.

Thanks to the Thermacut® Torch Connection System (TCS), changing the torch is a quick and easy process. The powerful torches are the result of decades of experience in the field of plasma cutting. They feature an extremely robust and durable design in which all consumables can be replaced quickly and easily.

BENEFITS

- High-performant torches for mechanised applications and handheld use
- Ergonomic handheld torches for safe and reliable holding and guiding in all positions
- Compact and flexible for handheld applications, even in the case of tight radii or gouging of fillet welds
- 100% duty cycle at 40 A (3 phase), ideal for continuous use
- Ideal for plate thicknesses of up to 25 mm and more with high power reserves
- Perfect power/weight ratio
- Consumables with an extended lifetime
- Quick and tool-free replacement of consumables
- Piercing max. 10 mm
- Perfectly designed for use with EX-TRAFIRE® 45SD power supplies

FHT-EX® 45TTH

HAND TORCH ASSEMBLY



Item	Part No.	Description	Pcs
1.	EX-2-133-001	FHT-EX45®TTH DEMO Hand Torch Assembly w/consumables/TCS13	1
	EX-2-101-001	FHT-EX45®TTH Hand Torch Assembly w/o consumables w/5m Lead/TCS13	1
	EX-2-103-001	FHT-EX45®TTH Hand Torch Assembly w/o consumables w/8m Lead/TCS13	1
	EX-2-106-001	FHT-EX45®TTH Hand Torch Assembly w/o consumables w/15m Lead/TCS13	1
⊕	2. EX-0-321-003	Latch with Key Assembly	1

⊕ LATCH WITH KEY IS NOT CONTENT OF TORCHES ABOVE. IF YOU NEED IT, YOU HAVE TO ORDER SEPARATELY.

FHT-EX® 45TTH

HAND TORCH COMPONENTS

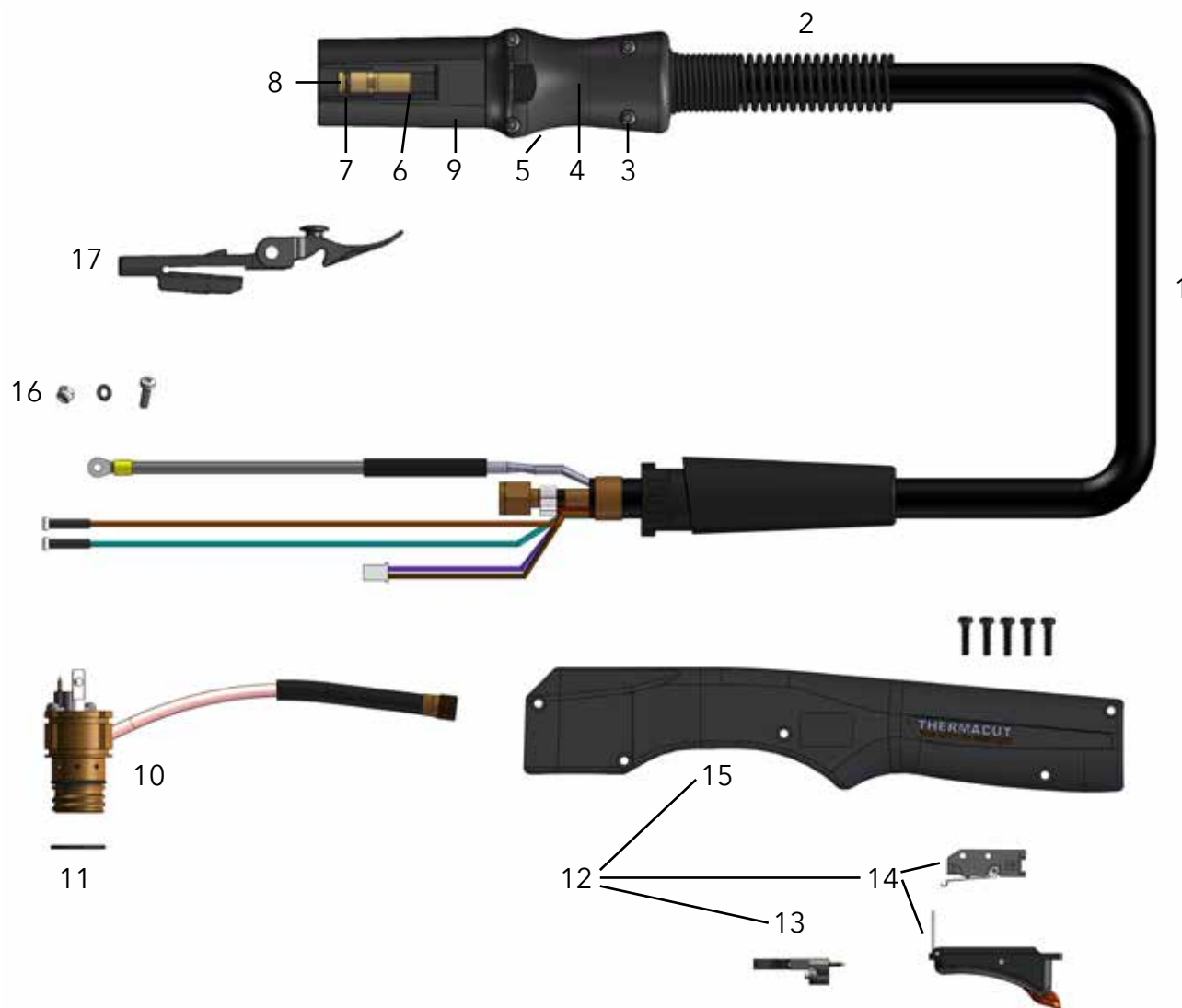

Item	Part No.	Description	Pcs	Item	Part No.	Description	Pcs
1.	EX-2-331-001	FHT-EX®45TTH Hand Torch Lead Replacement Kit 5m Lead/TCS13	1	9.	EX-0-323-001	TCS13 Plug Body	1
1.	EX-2-333-001	FHT-EX®45TTH Hand Torch Lead Replacement Kit 8m Lead/TCS13	1	10.	EX-2-302-001	Hand Torch Body FHT-EX®45TTH	1
1.	EX-2-336-001	FHT-EX®45TTH Hand Torch Lead Replacement Kit 15m Lead/TCS13	1	11.	EX-5-431-050	O-Ring (fitted on the torch body)	2
2.	EX-5-318-001	TCS Plug Spring Stain Relief	1	12.	EX-2-314-001	FHT-EX®45TTH Hand Torch Handle Replacement Kit	1
3.	EX-0-325-015	TCS Clam Shell Screw	1	13.	EX-2-305-001	Cap-sensor Replacement Kit with Screws/ Hand Torch	1
4.	EX-0-325-002	TCS Clam Shell Upper	1	14.	EX-2-313-001	Safety Trigger with start switch	1
5.	EX-0-325-001	TCS Clam Shell Lower	1	15.	EX-2-308-001	Hand Torch Handle with Screws	1
6.	EX-0-325-010	Retaining Ring (Outer circlip ring)	1	16.	EX-5-372-010	Cathode mounting kit	1
7.	EX-0-325-009	O-Ring (fitted in the TCS plug)	1	17.	EX-0-321-003	Latch w/Key Assembly	1
8.	EX-0-325-005	Male Crimp Pin for TCS Plug	1				

FHT-EX® 45TTM

MACHINE TORCH ASSEMBLY



Item	Part No.	Description	Pcs
1.	EX-2-233-001	FHT-EX®45TTM DEMO Machine Torch Assembly w/consumables/TCS13	1
	EX-2-202-001	FHT-EX®45TTM Machine Torch Assembly w/o consumables w/5m Lead/TCS13	1
	EX-2-204-001	FHT-EX®45TTM Machine Torch Assembly w/o consumables w/8m Lead/TCS13	1
	EX-2-207-001	FHT-EX®45TTM Machine Torch Assembly w/o consumables w/15m Lead/TCS13	1
⊕	2.	EX-0-321-003 Latch with Key Assembly	1

⊕ LATCH WITH KEY IS NOT CONTENT OF TORCHES ABOVE. IF YOU NEED IT, YOU HAVE TO ORDER SEPARATELY.

FHT-EX® 45TTM

MACHINE TORCH COMPONENTS

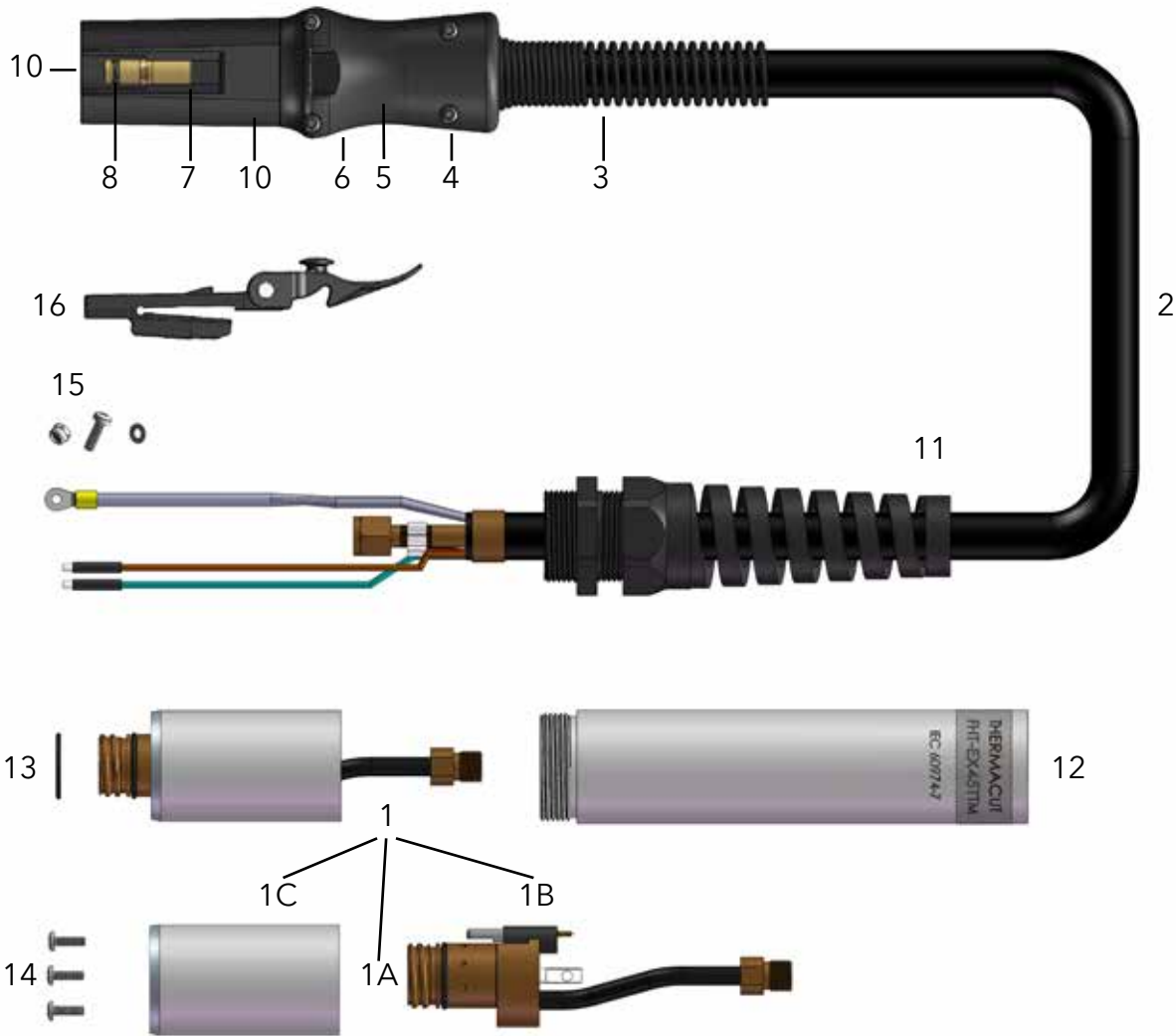

Item	Part No.	Description	Pcs	Item	Part No.	Description	Pcs
1.	EX-2-301-001	Machine Torch Body Assembly FHT-EX®45TTM	1	7.	EX-0-325-010	Retaining Ring (Outer circlip ring)	1
1a.	EX-2-301-002	Machine Torch Body FHT-EX®45TTM	1	8.	EX-0-325-009	O-Ring (fitted in the TCS plug)	1
1b.	EX-5-304-001	Cap Sensor Replacement Kit with Screws / Machine Torch	1	9.	EX-0-325-005	Male Crimp Pin for TCS Plug	1
1c.	EX-5-306-002	Torch Mounting Sleeve (incl. 3 screws)	1	10.	EX-0-323-001	TCS13 Plug Body	1
2.	EX-2-352-001	FHT-EX®45TTM Machine Torch Lead Replacement Kit 5m Lead/TCS13	1	11.	EX-5-317-021	Machine Torch Strain Relief	1
	EX-2-354-001	FHT-EX®45TTM Machine Torch Lead Replacement 8m Lead/TCS13	1	12.	EX-2-306-001	FHT-EX®45TTM Standard Mounting Tube w/o Rack	1
	EX-2-357-001	FHT-EX®45TTM Machine Torch Lead Replacement 15m Lead/TCS13	1	13.	EX-5-431-050	O-Ring (fitted on the torch body)	2
3.	EX-5-318-001	TCS Plug Spring Strain Relief	1	14.	EX-5-372-005	Torch Mounting Screws Kit (incl. 3 screws)	1
4.	EX-0-325-015	TCS Clam Shell Screw Kit (incl. 4 screws)	1	15.	EX-5-372-010	Cathode Mounting Kit	1
5.	EX-0-325-002	TCS Clam Shell Upper	1	16.	EX-0-321-003	Latch w/Key Assembly	1
6.	EX-0-325-001	TCS Clam Shell Lower	1				

CONSUMABLES

HAND / MACHINE TORCH CONSUMABLES

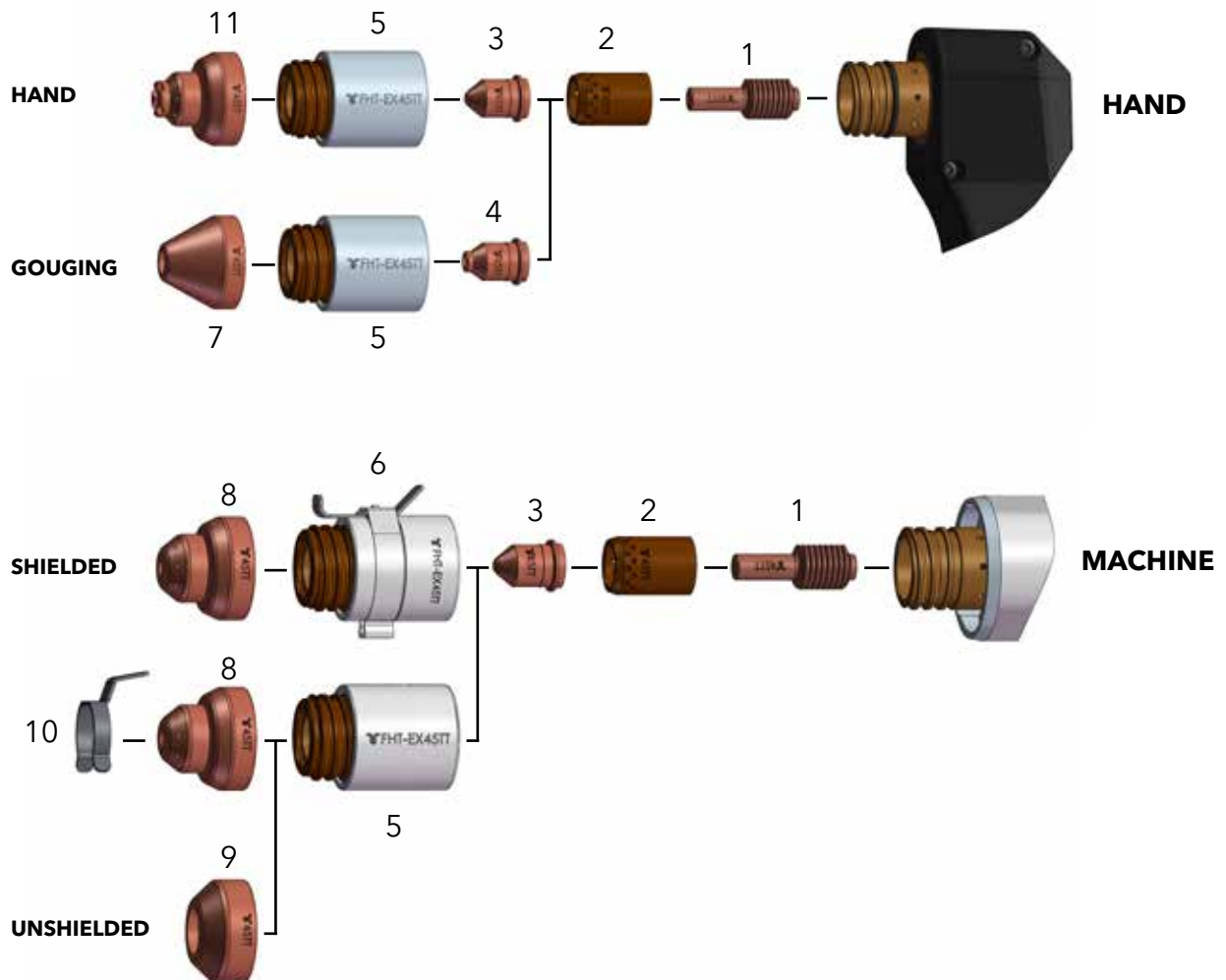

Item	Part No.	Description	Pcs	Item	Part No.	Description	Pcs
1.	EX-2-401-201	Electrode	5	7.	EX-2-419-202	Gouging Shield	1
2.	EX-2-404-201	Swirl ring	1	8.	EX-2-421-201	Machine Shield	1
3.	EX-2-409-201	Nozzle	5	9.	EX-2-423-211	Deflector	1
4.	EX-2-409-202	Gouging nozzle	5	10.	EX-2-428-011	IHS Ohmic Clip	1
5.	EX-2-415-201	Retaining Cap	1	11.	EX-2-419-201	Hand (contact) Shield	1
6.	EX-2-415-202	Retaining Cap w/IHS Tab	1				

* IN COUNTRIES FOLLOWING CE STANDARDS, UNSHIELDED CONSUMABLE CONFIGURATION MAY ONLY BE USED IN MECHANIZED TORCH APPLICATIONS.

EX-TRA-FIRE[®] 55SD

**BEST IN CLASS
PLASMA CUTTING SYSTEM**



EX-TRAFIRE® 55SD



SIMPLE OPERATION



- + Intuitive control
- + Protected filter regulator
- + Engineered for professional applications

HIGHEST APPLICATION FLEXIBILITY



- + Plate thicknesses up to 30 mm +
- + Lightweight, exceptionally portable
- + TCS quick change flexible torch packages
- + Suitable for generator use

EX-TRA PERFORMANCE



- + Cutting, gouging, grid mode
- + Exact cuts
- + High duty cycle

BEST COST-EFFECTIVENESS

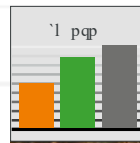

- + Low investment for high performance
- + Enhanced consumable lifetime
- + Reduced costs of ownership

EX-TRAFIRE® 55SD

SPECIFICATIONS

- AMPS (A)** 30-55
- INPUT VOLTAGE (VAC)** 3 X 220VAC ± 15 %, CE 3 X 400VAC ± 15 %
- PLASMA GAS** COMPRESSED AIR
- CERTIFICATION** CE, C-TICK, CCC
- MODES** CUTTING / GRID CUTTING / GOUGING
- FREQUENCY (Hz)** 50/60
- MAXIMUM INPUT POWER (kVA)** 11.9 kVA @ 3×220 VAC / 13.7 kVA @3×400 VAC
- OUTPUT VOLTAGE (VDC)** 140 V @ 3×220 VAC / 170 V @ 3×400 VAC
- DUTY CYCLE @ 40 °C** 50% @ 55A, 100% @ 41A
- DIMENSION (L × H × W) MM** 469×228×177
- WEIGHT (KG)** 11.8
- RECOMMENDED CUTTING CAPACITY (MM)** 20
- SEVERANCE CUTTING CAPACITY (MM)** 30
- PIERCING CUTTING CAPACITY (MM)** 20
- AIR FLOW @ (LPM/BAR)** 100 @ 5,2
- MAXIMUM INPUT PRESSURE (BAR/PSI)** 10/145
- PROTECTION LEVEL** IP23S
- INSULATION CLASS** H/F
- CNC INTERFACE** OPTIONAL
- INDUSTRY 4.0** NO
- TYPE OF TORCH** FHT-EX®105RTX H/M

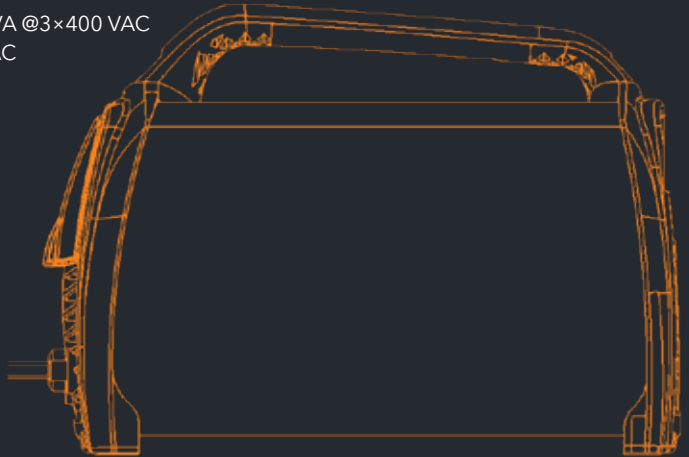

MILD STEEL CUTTING CAPACITY IN MILLIMETRES

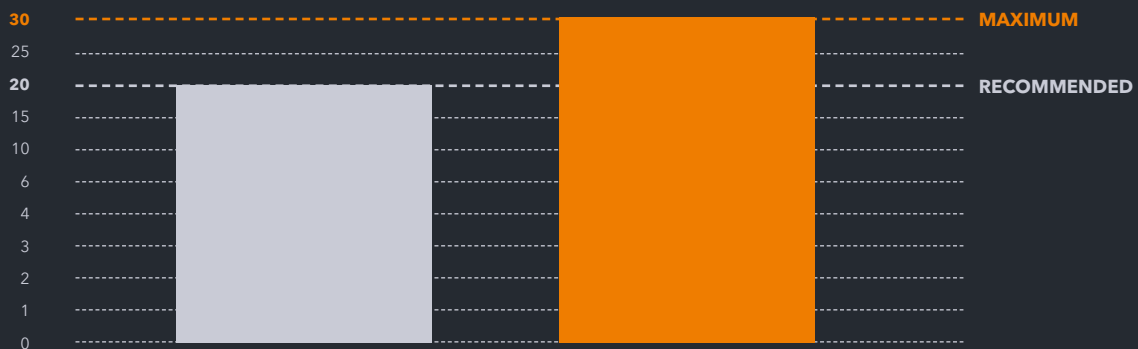

COMPARISON WITH COMPETITIVE PLASMA CUTTING MACHINES

EX-TRAFIRE®55SD IS THE MOST POWERFUL SYSTEM IN IT'S CLASS.



EX-TRAFIRE® 55SD

ORDERING INFORMATION

Description	Length	Part No.
MANUAL PLASMA CUTTING SYSTEMS		
EX-TRAFIRE®55SD/CE/3x400V Hand System/FHT-EX®105RTXH Torch 8m/H Starter Kit	8m	EX-3-010-034
EX-TRAFIRE®55SD/CE/3x400V Hand System/FHT-EX®105RTXH Torch 15m/H Starter Kit	15m	EX-3-010-035
EX-TRAFIRE®55SD/CE/3x220V Hand System/FHT-EX®105RTXH Torch 8m/H Starter Kit	8m	EX-3-010-036
EX-TRAFIRE®55SD/CE/3x220V Hand System/FHT-EX®105RTXH Torch 15m/H Starter Kit	15m	EX-3-010-037
MECHANIZED PLASMA CUTTING SYSTEMS		
EX-TRAFIRE®55SD/CE/3x400V M System/FHT-EX®105RTXM-NR Torch 8m/M Starter Kit	8m	EX-3-011-030
EX-TRAFIRE®55SD/CE/3x400V M System/FHT-EX®105RTXM-NR Torch 15m/M Starter Kit	15m	EX-3-011-031
EX-TRAFIRE®55SD/CE/3x220V M System/FHT-EX®105RTXM-NR Torch 8m/M Starter Kit	8m	EX-3-011-032
EX-TRAFIRE®55SD/CE/3x220V M System/FHT-EX®105RTXM-NR Torch 15m/M Starter Kit	15m	EX-3-011-033
PLASMA POWER SUPPLY UNITS		
EX-TRAFIRE®55SD/CE/3x400V power supply unit (fully-equipped)		EX-3-001-001
EX-TRAFIRE®55SD/CE/3x220V power supply unit (fully-equipped)		EX-3-001-005

AVAILABLE CONSUMABLE KITS

Description	Pcs	Part No.
Hand Torch Consumable Kit 55/65A	1	EX-3-443-001
Machine Torch Consumable Kit 55/65A	1	EX-3-444-001

ACCESSORIES

Description	Pcs	Part No.
DN 7.2 ES Quick Connect Plug with female thread G 1/4"	1	EX-0-802-000
DN 7.2 ES Quick Connect Plug with male thread G 1/4"	1	EX-0-802-001
DN 7.2 ES Quick Connect Coupling with male thread G 1/4"	1	EX-0-802-002
Grease 25ml	1	EX-0-805-001
Filter-EX Compressed Air Filter	1	EX-0-804-001
Filter-EX Air Filter Cartridge	8	EX-0-804-002

EX-TRAFIRE® 55SD



FRONT VIEW



BACK VIEW



SIDE VIEW

EX-TRA[®]FIRE 75SD

**ENGINEERED FOR ENDURANCE
PLASMA CUTTING SYSTEM**



EX-TRAFIRE 75SD

EX-TRAFIRE® 75SD



DUTY CYCLE
100%
@75A

MATERIAL
35+ mm
THICKNESS

CUTTING
16,5kW
OUTPUT

SIMPLE OPERATION



- + Easy to read, blue LED display
- + Protected filter regulator, easy to adjust
- + Engineered for professionals

HIGHEST APPLICATION FLEXIBILITY



- + Plate thicknesses up to 35 mm +
- + Powerful and lightweight
- + TCS quick change flexible torch packages
- + Suitable for generator use

EX-TRA PERFORMANCE



- + Cutting, gouging, grid mode
- + Engineered especially for mechanised applications
- + 100% duty cycle

BEST COST-EFFECTIVENESS

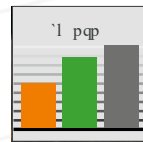

- + Reduced capital outlay
- + Enhanced consumable lifetime
- + Reduced costs of ownership

EX-TRAFIRE® 75SD

SPECIFICATIONS

- AMPS (A)** 30-75
- INPUT VOLTAGE (VAC)** 3×220 VAC ± 15 % / 3×400 VAC ± 15 %
- PLASMA GAS** COMPRESSED AIR
- CERTIFICATION** CE, C-TICK, CCC
- MODES** CUTTING / GOUGING / GRID CUTTING
- FREQUENCY (Hz)** 50/60
- MAXIMUM INPUT POWER (kVA)** 14.71 kVA @ 3X220 VAC / 17.6 kVA @ 3X400 VAC
- OUTPUT VOLTAGE (VDC)** 170 V (EXTRA-BOOST 220V)
- DUTY CYCLE @ 40 °C** 100% @ 75A
- DIMENSION (L × H × W) MM** 560X400X265
- WEIGHT (KG)** 24
- RECOMMENDED CUTTING CAPACITY (MM)** 25
- SEVERANCE CUTTING CAPACITY (MM)** 35
- PIERCING CUTTING CAPACITY (MM)** 20
- AIR FLOW @ (LPM/BAR)** 110 @ 5.2
- MAXIMUM INPUT PRESSURE (BAR/PSI)** 10/145
- PROTECTION LEVEL** IP23S
- INSULATION CLASS** H/F
- CNC INTERFACE** OPTIONAL
- INDUSTRY 4.0** NO
- TYPE OF TORCH** FHT-EX®105RTX H/M

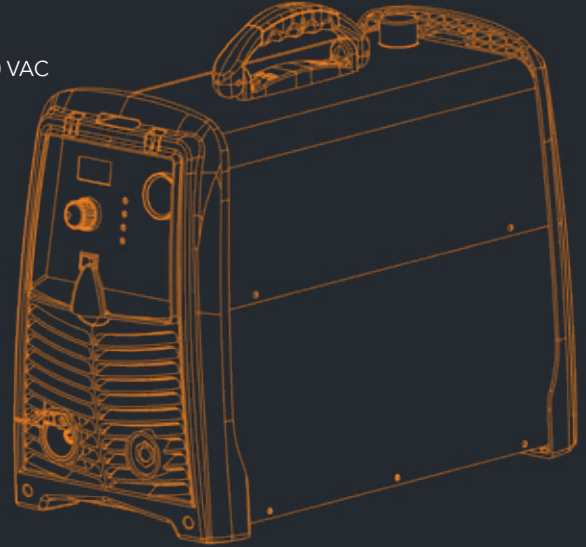

MILD STEEL CUTTING CAPACITY IN MILLIMETRES

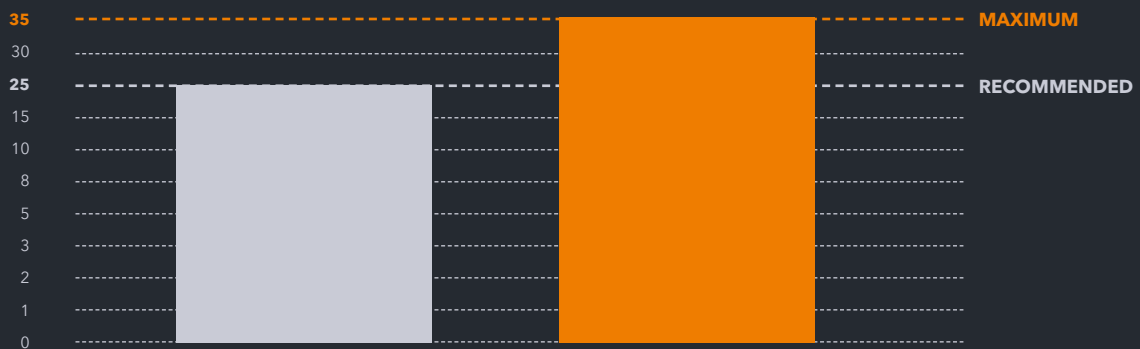

COMPARISON WITH COMPETITIVE PLASMA CUTTING MACHINES

EX-TRAFIRE® 75SD IS THE MOST POWERFUL SYSTEM IN IT'S CLASS.



EX-TRAFIRE® 75SD

ORDERING INFORMATION

Description	Length	Part No.
MANUAL PLASMA CUTTING SYSTEMS		
EX-TRAFIRE® 75SD/CE/3x400V Hand System/FHT-EX® 105RTXH Torch 8m/H Starter Kit	8m	EX-4-010-041
EX-TRAFIRE® 75SD/CE/3x400V Hand System/FHT-EX® 105RTXH Torch 15m/H Starter Kit	15m	EX-4-010-042
EX-TRAFIRE® 75SD/CE/3x220V Hand System/FHT-EX® 105RTXH Torch 8m/H Starter Kit	8m	EX-4-010-043
EX-TRAFIRE® 75SD/CE/3x220V Hand System/FHT-EX® 105RTXH Torch 15m/H Starter Kit	15m	EX-4-010-044
MECHANIZED PLASMA CUTTING SYSTEMS		
EX-TRAFIRE® 75SD/CE/3x400V M System/FHT-EX® 105RTXM-NR Torch 8m/M Starter Kit	8m	EX-4-011-030
EX-TRAFIRE® 75SD/CE/3x400V M System/FHT-EX® 105RTXM-NR Torch 15m/M Starter Kit	15m	EX-4-011-031
EX-TRAFIRE® 75SD/CE/3x220V M System/FHT-EX® 105RTXM-NR Torch 8m/M Starter Kit	8m	EX-4-011-032
EX-TRAFIRE® 75SD/CE/3x220V M System/FHT-EX® 105RTXM-NR Torch 15m/M Starter Kit	15m	EX-4-011-033
PLASMA POWER SUPPLY UNITS		
EX-TRAFIRE® 75SD/CE/3x400V power supply unit (fully-equipped)		EX-4-001-004
EX-TRAFIRE® 75SD/CE/3x220V power supply unit (fully-equipped)		EX-4-001-005

AVAILABLE CONSUMABLE KITS

Description	Pcs	Part No.
Hand Torch Consumable Kit 55/65A	1	EX-3-443-001
Machine Torch Consumable Kit 55/65A	1	EX-3-444-001
Hand Torch Consumable Kit 75/85A	1	EX-4-443-001
Machine Torch Consumable Kit 75/85A	1	EX-4-444-001

ACCESSORIES

Description	Pcs	Part No.
DN 7.2 ES Quick Connect Plug with female thread G 1/4"	1	EX-0-802-000
DN 7.2 ES Quick Connect Plug with male thread G 1/4"	1	EX-0-802-001
DN 7.2 ES Quick Connect Coupling with male thread G 1/4"	1	EX-0-802-002
Grease 25ml	1	EX-0-805-001
Filter-EX Compressed Air Filter	1	EX-0-804-001
Filter-EX Air Filter Cartridge	8	EX-0-804-002

EX-TRAFIRE® 75SD



FRONT VIEW



BACK VIEW



SIDE VIEW

EX-TRA-FIRE[®] 100SD

**BUILT FOR POWER
PLASMA CUTTING SYSTEM**



EX-TRAFIRE® 100SD



SIMPLE OPERATION



- + Intuitive control
- + Exceptionally robust
- + Engineered for demanding professionals

EX-TRA PERFORMANCE



- + High cutting speed
- + Precise cuts
- + Industry leading duty cycle

HIGHEST APPLICATION FLEXIBILITY



- + Plate thicknesses up to 50 mm +
- + Powerful and lightweight
- + TCS quick change flexible torch packages
- + Suitable for generator use

BEST COST-EFFECTIVENESS

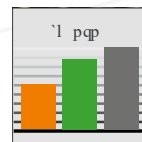

- + Reduced capital outlay
- + Longer consumable lifetime
- + Considerably reduced costs of ownership

EX-TRAFIRE® 100SD

SPECIFICATIONS

- AMPS (A)** 30-100
- INPUT VOLTAGE (VAC)** 3X400 VAC ± 15 %
- PLASMA GAS** COMPRESSED AIR
- CERTIFICATION** CE, C-TICK, CCC
- MODES** CUTTING / GOUGING / GRID CUTTING
- FREQUENCY (Hz)** 50/60
- MAXIMUM INPUT POWER (kVA)** 24.6
- OUTPUT VOLTAGE (VDC)** 170 (EXTRA-BOOST 220V)
- DUTY CYCLE @ 40 °C** 50% @ 100A, 100% @ 80A
- DIMENSION (L x H x W) MM** 560x400x265
- WEIGHT (KG)** 24
- RECOMMENDED CUTTING CAPACITY (MM)** 35
- SEVERANCE CUTTING CAPACITY (MM)** 50
- PIERCING CUTTING CAPACITY (MM)** 20
- AIR FLOW @ (LPM/BAR)** 135 @ 5.2
- MAXIMUM INPUT PRESSURE (BAR/PSI)** 10/145
- PROTECTION LEVEL** IP23S
- INSULATION CLASS** H/F
- CNC INTERFACE** OPTIONAL
- INDUSTRY 4.0** NO
- TYPE OF TORCH** FHT-EX®105RTX H/M

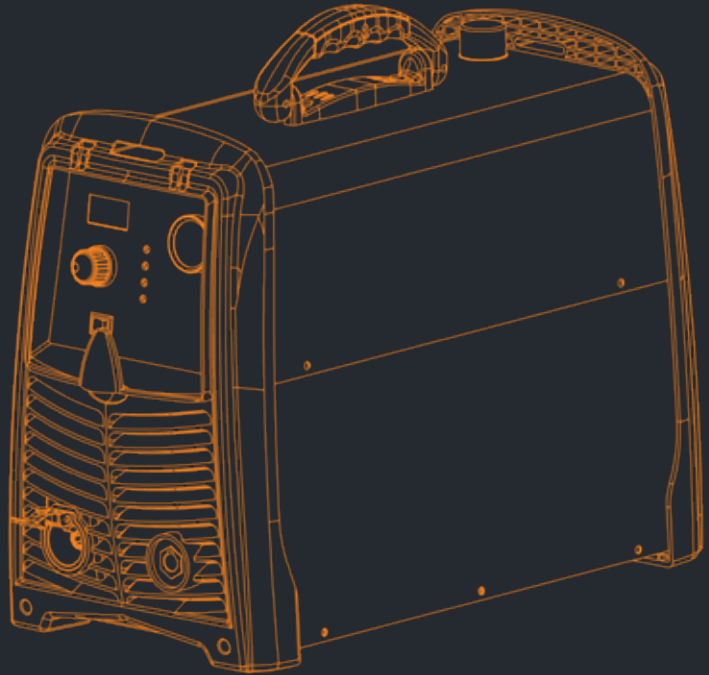

MILD STEEL CUTTING CAPACITY IN MILLIMETRES

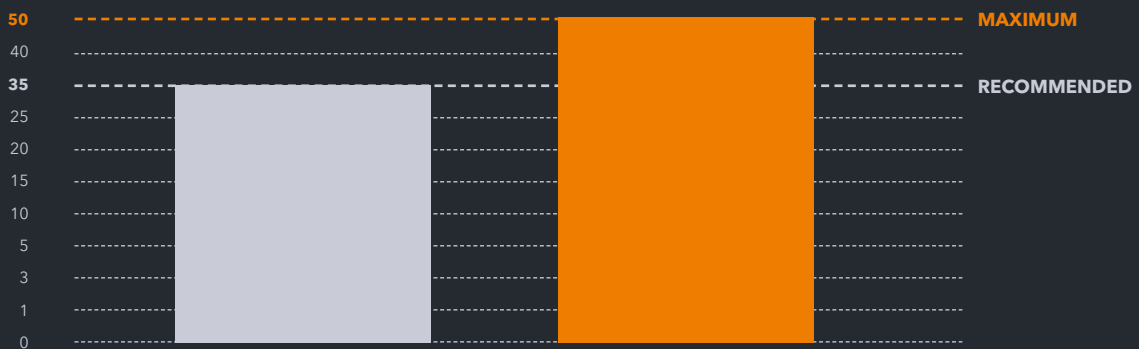

COMPARISON WITH COMPETITIVE PLASMA CUTTING MACHINES

EX-TRAFIRE® 100SD IS THE MOST POWERFUL SYSTEM IN IT'S CLASS.



EX-TRAFIRE® 100SD

ORDERING INFORMATION

Description	Length	Part No.
MANUAL PLASMA CUTTING SYSTEMS		
EX-TRAFIRE®100SD/CE/3x400V Hand System/FHT-EX®105RTXH Torch 8m/H Starter Kit	8m	EX-5-010-033
EX-TRAFIRE®100SD/CE/3x400V Hand System/FHT-EX®105RTXH Torch 15m/H Starter Kit	15m	EX-5-010-034
MECHANIZED PLASMA CUTTING SYSTEMS		
EX-TRAFIRE®100SD/CE/3x400V M System/FHT-EX®105RTXM-NR Torch 8m/M Starter Kit	8m	EX-5-011-030
EX-TRAFIRE®100SD/CE/3x400V M System/FHT-EX®105RTXM-NR Torch 15m/M Starter Kit	15m	EX-5-011-031
PLASMA POWER SUPPLY UNITS		
EX-TRAFIRE®100SD/CE/3x400V power supply unit (fully-equipped)		EX-5-001-003

AVAILABLE CONSUMABLE KITS

Description	Pcs	Part No.
Hand Torch Consumable Kit 55/65A	1	EX-3-443-001
Hand Torch Consumable Kit 75/85A	1	EX-4-443-001
Hand Torch Consumable Kit 100/105A	1	EX-5-443-001
Machine Torch Consumable Kit 55/65A	1	EX-3-444-001
Machine Torch Consumable Kit 75/85A	1	EX-4-444-001
Machine Torch Consumable Kit 100/105A	1	EX-5-444-001

ACCESSORIES

Description	Pcs	Part No.
DN 7.2 ES Quick Connect Plug with female thread G 1/4"	1	EX-0-802-000
DN 7.2 ES Quick Connect Plug with male thread G 1/4"	1	EX-0-802-001
DN 7.2 ES Quick Connect Coupling with male thread G 1/4"	1	EX-0-802-002
Grease 25ml	1	EX-0-805-001
Filter-EX Compressed Air Filter	1	EX-0-804-001
Filter-EX Air Filter Cartridge	8	EX-0-804-002

EX-TRAFIRE® 100SD



FRONT VIEW



BACK VIEW



SIDE VIEW

FHT-EX[®] 105RTX

HAND / MACHINE TORCHES AND CONSUMABLES

SUITABLE FOR EX-TRAFIRE[®] 55SD/75SD/100SD



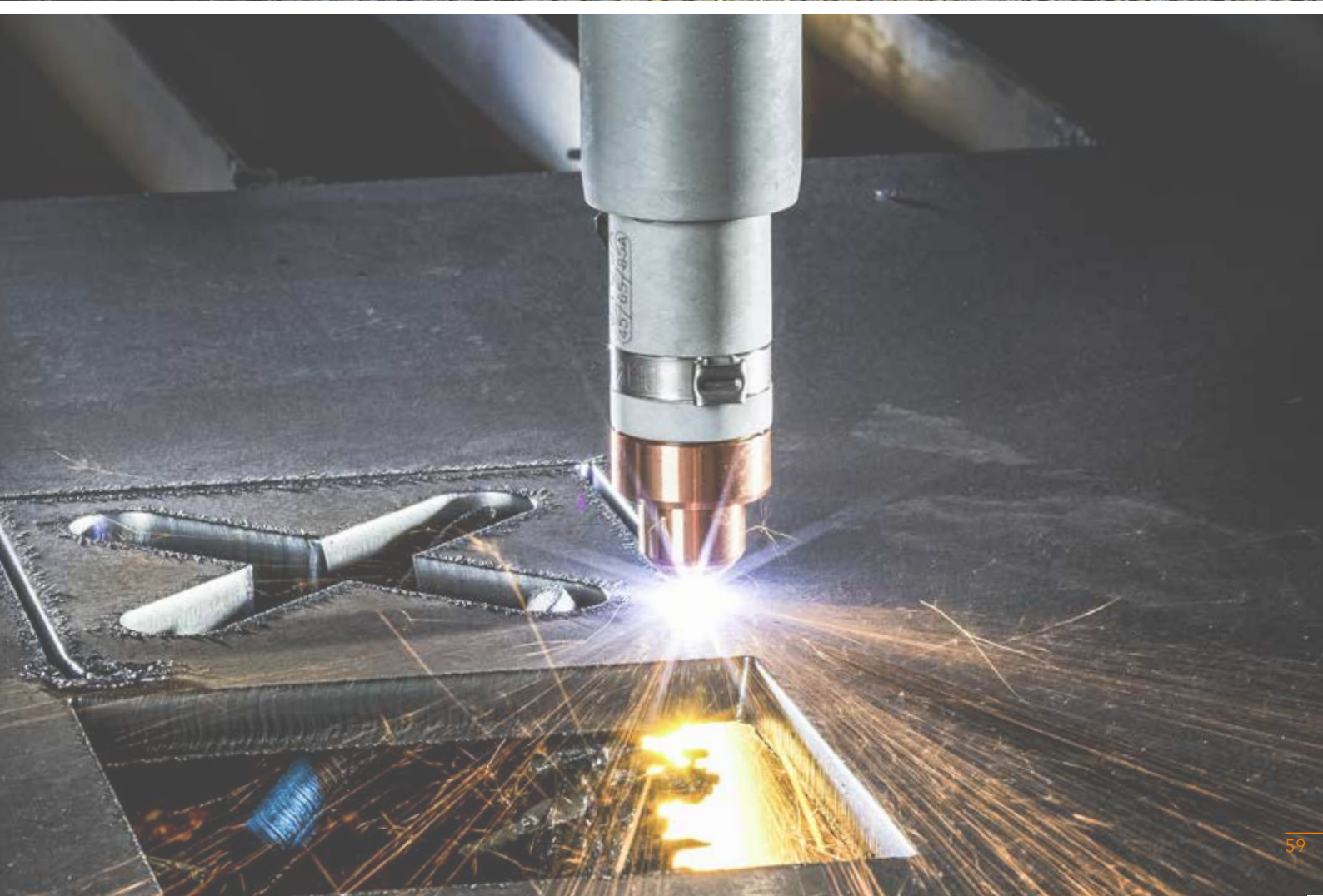

FHT-EX® 105RTXH



EXTREMELY FLEXIBLE AND POWERFUL



The extremely high-performant FHT-EX®105RTXH hand torch is ideal for meeting tough demands in continuous industrial operation. This torch is optimally designed for use with EX-TRAFIRE® 55SD, 75SD and 100SD power supplies and are suitable for cutting, gouging and grid-cutting. Depending on the power supply used, they can cut plate thickness of up to 50 mm and more precisely and quickly.

Thanks to the Thermacut® Torch Connection System (TCS), changing the torch is a quick and easy process. These particularly powerful torches are the result of decades of experience in the field of plasma cutting. They feature an extremely robust and durable design in which all consumables can be replaced quickly and easily.

BENEFITS

- Extremely high-performance torches for handheld use
- Ergonomic handheld torches for safe and reliable holding and guiding in all positions
- Compact and particularly flexible for handheld applications, even in the case of tight radii
- 100% duty cycle at 100/105 A, ideal for continuous industrial use
- Ideal for plate thicknesses of up to 50 mm and more with high power reserves
- Consumables with an extended lifetime
- Quick and tool-free replacement of consumables
- Piercing max. 20 mm
- Perfectly designed for use with EX-TRAFIRE® 55SD, 75SD and 100SD power supplies

FHT-EX® 105RTXH

HAND TORCH ASSEMBLY AND TORCH COMPONENTS



Item	Part No.	Description	Pcs
1.	EX-5-140-002	FHT-EX®105RTXH Hand Torch w/o Rack Assy-w/o consumables w/8m Lead/TCS13	1
	EX-5-140-003	FHT-EX®105RTXH Hand Torch w/o Rack Assy-w/o consumables w/15m Lead/TCS13	1
2.	EX-0-321-003	Latch w/Key Assembly	1

LATCH WITH KEY IS NOT CONTENT OF TORCHES ABOVE. IF YOU NEED IT, YOU HAVE TO ORDER SEPARATELY.

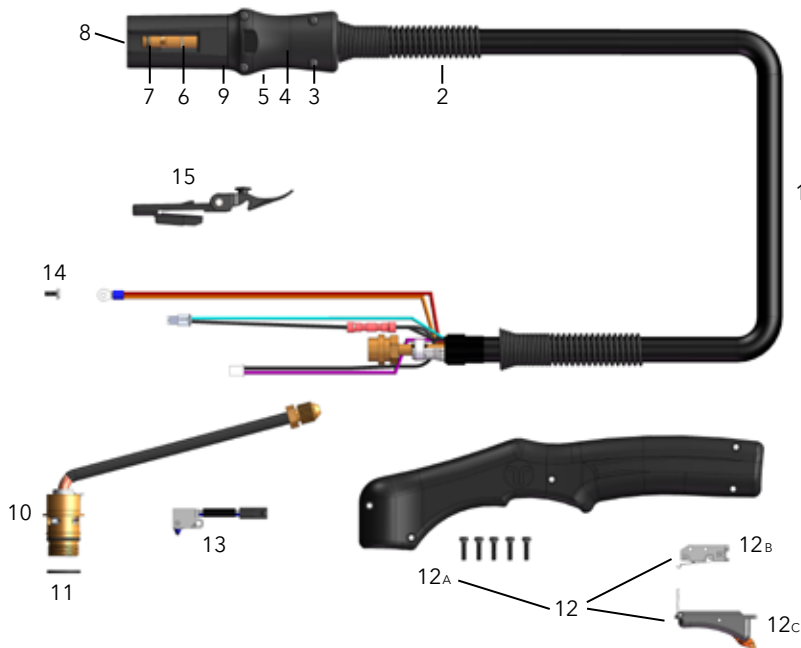

Item	Part No.	Description	Pcs	Item	Part No.	Description	Pcs
1.	EX-5-374-005	FHT-EX®105RTXH Hand Torch Lead Replacement 8m (26')/TCS13	1	10.	EX-5-302-030	Hand Torch Body Replacement Kit	1
1.	EX-5-374-006	FHT-EX®105RTXH Hand Torch Lead Replacement 15m (50')/TCS13	1	11.	EX-5-431-050	Torch Body O-Ring	2
2.	EX-5-318-001	TCS Plug Spring Stain Relief	1	12.	EX-5-314-030	Hand Torch Handle Replacement Kit	1
3.	EX-0-325-015	TCS Clam Shell Screw Kit (incl. 4 screws)	1	12a.	EX-5-308-030	Hand Torch Handle with Screws	1
4.	EX-0-325-002	TCS Clam Shell Upper	1	12b.	EX-5-313-030	Safety Trigger Micro-Switch	1
5.	EX-0-325-001	TCS Clam Shell Lower	1	12c.	EX-5-313-031	Safety Trigger	1
6.	EX-0-325-010	Retaining Ring (Outer circlip ring)	1	13.	EX-5-305-001	Cap Sensor Microswitch Assembly/Hand Torch	1
7.	EX-0-325-009	O-Ring (fitted in the TCS plug)	1	14.	EX-5-372-030	Pilot Cable Screw	1
8.	EX-0-325-005	Male Crimp Pin for TCS Plug	1	15.	EX-0-321-003	Latch w/Key Assembly	1
9.	EX-0-323-001	TCS13 Plug Body	1				

CONSUMABLES

HAND TORCH STANDARD CONSUMABLES - 45-85A

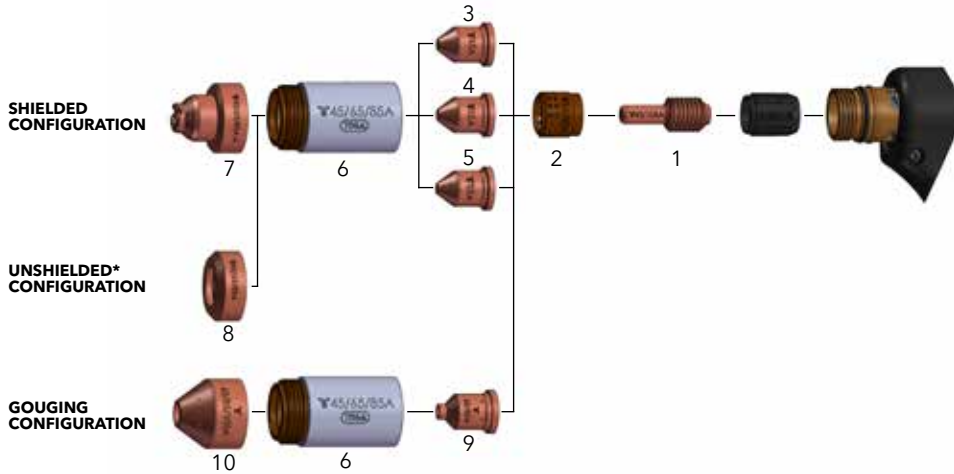

Item	Part No.	Description	Pcs	Item	Part No.	Description	Pcs
1.	EX-5-402-030	Electrode 45-105A (5pcs package) **	1x5	6.	EX-5-415-030	Retaining Cap 45-85A	1
2.	EX-5-404-031	Swirl Ring 45-85A	1	7.	EX-5-419-030	Shield 45-85A, Hand	1
3.	EX-5-410-036	Nozzle 45A (5pcs package) **	1x5	8.	EX-5-423-031	Deflector 45-105A	1
4.	EX-5-410-037	Nozzle 55/65A (5pcs package) **	1x5	9.	EX-5-440-031	Nozzle 45-85A, Gouging (5pcs package) **	1x5
5.	EX-5-410-038	Nozzle 75/85A (5pcs package) **	1x5	10.	EX-5-440-030	Shield 45-105A, Gouging	1

* IN COUNTRIES FOLLOWING CE STANDARDS, UNSHIELDED CONSUMABLE CONFIGURATION MAY ONLY BE USED IN MECHANIZED TORCH APPLICATIONS.

** THIS PART IS AVAILABLE IN 5PCS SET ONLY

HAND TORCH STANDARD CONSUMABLES - 105A

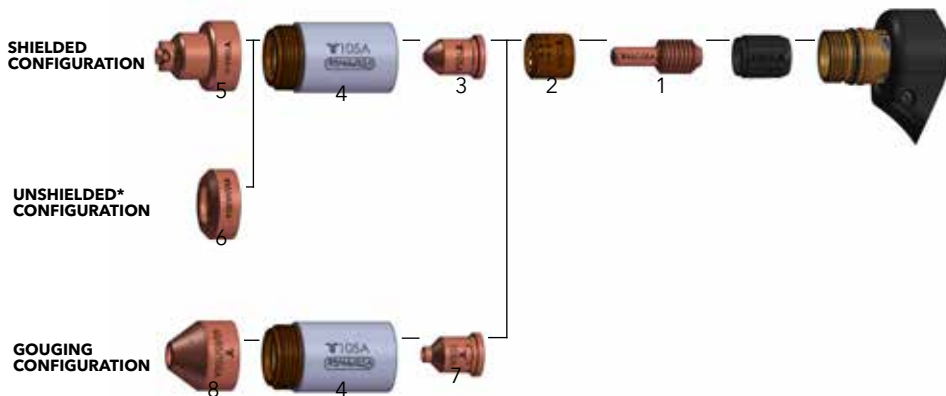

Item	Part No.	Description	Pcs	Item	Part No.	Description	Pcs
1.	EX-5-402-030	Electrode 45-105A (5pcs package) **	1x5	5.	EX-5-420-030	Shield 100/105A, Hand	1
2.	EX-5-404-032	Swirl Ring 100/105A	1	6.	EX-5-423-031	Deflector 45-105A	1
3.	EX-5-410-039	Nozzle 100/105A (5pcs package) **	1x5	7.	EX-5-440-032	Nozzle 100/105A, Gouging (5pcs package) **	1x5
4.	EX-5-415-032	Retaining Cap 100/105A	1	8.	EX-5-440-030	Shield 45-105A, Gouging	1

* IN COUNTRIES FOLLOWING CE STANDARDS, UNSHIELDED CONSUMABLE CONFIGURATION MAY ONLY BE USED IN MECHANIZED TORCH APPLICATIONS.

** THIS PART IS AVAILABLE IN 5PCS SET ONLY

CONSUMABLES

HAND TORCH CONSUMABLES - FINELINE

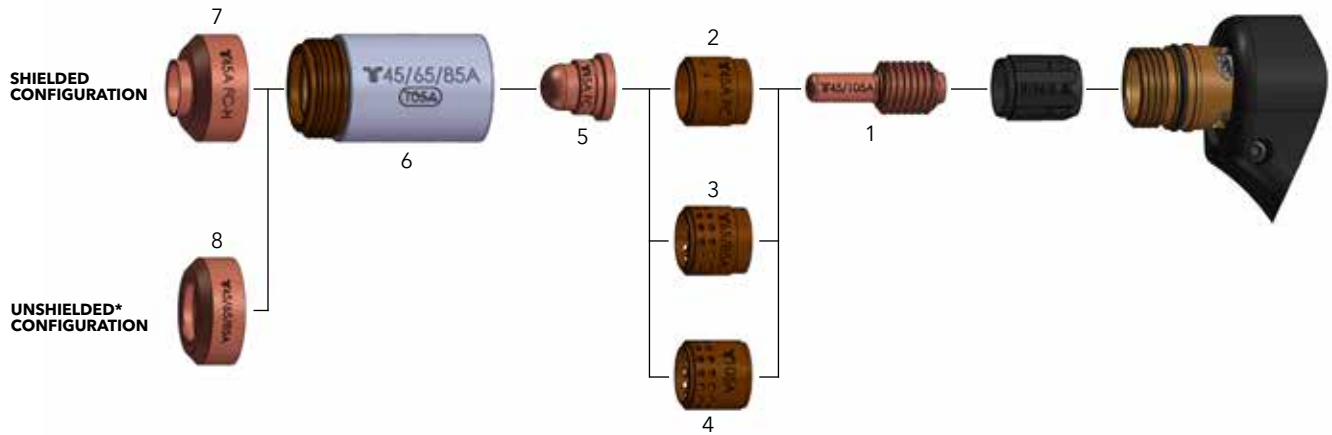

Item	Part No.	Description	Pcs	Item	Part No.	Description	Pcs
1.	EX-5-402-030	Electrode 45-105A (5pcs package) **	1x5	5.	EX-5-410-035	Nozzle 45A/FineLine (5pcs package) **	1x5
2.	EX-5-404-030	Swirl Ring 45-105A/FineLine	1	6.	EX-5-415-030	Retaining Cap 45-85A	1
3.	EX-5-404-031	Swirl Ring 45-85A	1	7.	EX-5-423-030	Deflector 45A/ FineLine	1
4.	EX-5-404-032	Swirl Ring 100/105A	1	8.	EX-5-423-031	Deflector 45-105A	

* IN COUNTRIES FOLLOWING CE STANDARDS, UNSHIELDED CONSUMABLE CONFIGURATION MAY ONLY BE USED IN MECHANIZED TORCH APPLICATIONS.

** THIS PART IS AVAILABLE IN 5PCS SET ONLY

FHT-EX® 105RTXM



DESIGNED FOR ACCURACY AND DURABILITY



The extremely high-performant FHT-EX®105RTXM machine torches are ideal for meeting tough demands in continuous industrial operation. These torches are optimally designed for use with EX-TRAFIRE® 55SD, 75SD and 100SD power supplies and are suitable for cutting, gouging and grid-cutting. Depending on the power supply used, they can cut plate thickness of up to 50 mm and more precisely and quickly.

Thanks to the Thermacut® Torch Connection System (TCS), changing the torch is a quick and easy process. These particularly powerful torches are the result of decades of experience in the field of plasma cutting. They feature an extremely robust and durable design in which all consumables can be replaced quickly and easily.

BENEFITS

- Extremely high-performance torches for mechanised applications
- 100% duty cycle at 100/1050 A, ideal for continuous industrial use
- Ideal for plate thicknesses of up to 50 mm and more with high power reserves
- Consumables with an extended lifetime
- Quick and tool-free replacement of consumables
- Piercing max. 20 mm
- Perfectly designed for use with EX-TRAFIRE® 55SD, 75SD and 100SD power supplies

FHT-EX® 105RTXM

MACHINE TORCH ASSEMBLY AND TORCH COMPONENTS

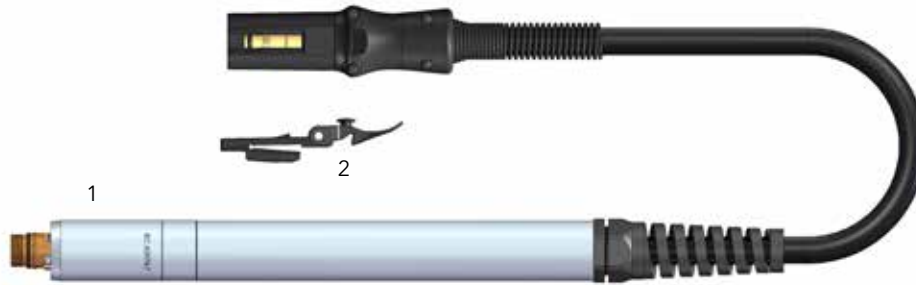

Item	Part No.	Description
1.	EX-5-240-001	FHT-EX®105RTXM Machine Torch w/o Rack Assy-w/o consumables w/8m Lead/ TCS13
	EX-5-240-005	FHT-EX®105RTXM Machine Torch w/o Rack Assy-w/o consumables w/15m Lead/ TCS13
2.	EX-0-321-003	Latch w/Key Assembly

LATCH WITH KEY IS NOT CONTENT OF TORCHES ABOVE. IF YOU NEED IT, YOU HAVE TO ORDER SEPARATELY.

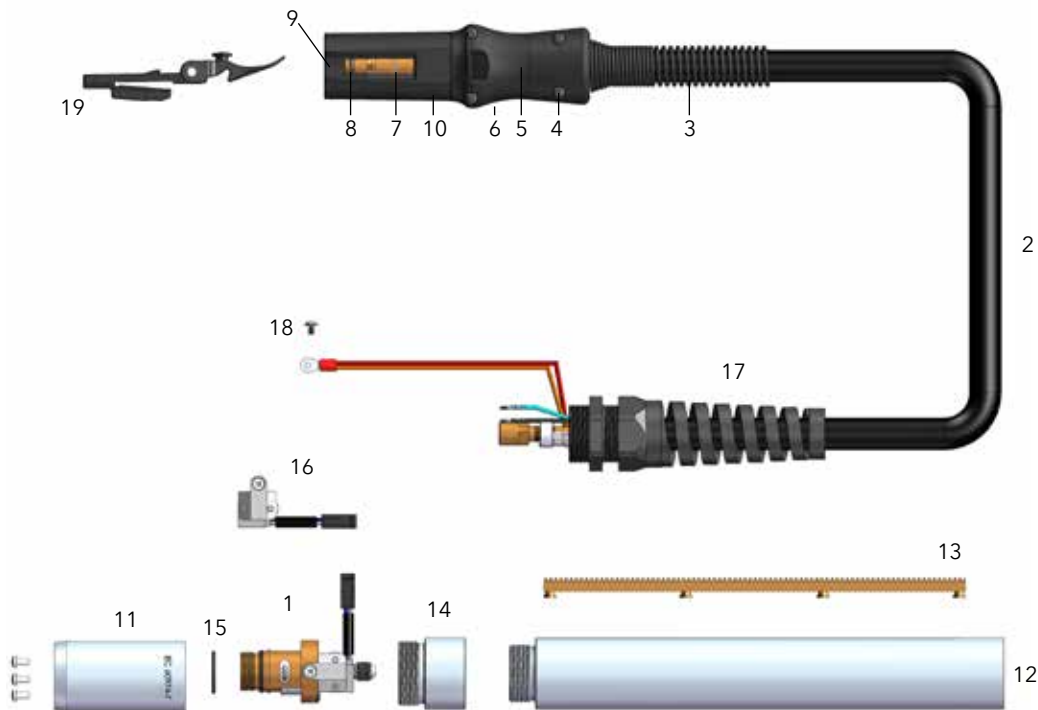

Item	Part No.	Description	Pcs	Item	Part No.	Description	Pcs
1.	EX-5-303-030	Machine Torch Body Replacement Kit	1	10.	EX-0-323-001	TCS13 Plug Body	1
2.	EX-5-375-001	FHT-EX®105RTXM Machine Torch Lead Replacement 8m (26')/TCS13	1	11.	EX-5-306-030	Torch Mounting Sleeve (incl. 3 screws)	1
2.	EX-5-375-002	FHT-EX®105RTXM Machine Torch Lead Replacement 15m (50')/TCS13	1	12.	EX-5-306-032	Standard Mounting Tube w/o Rack	1
3.	EX-5-318-001	TCS Plug Spring Strain Relief	1	13.	EX-5-306-033	Gear Rack	1
4.	EX-0-325-015	TCS Clam Shell Screw Kit (incl. 4 screws)	1	14.	EX-5-306-031	Standard Mounting Tube Reduction Nut	1
5.	EX-0-325-002	TCS Clam Shell Upper	1	15.	EX-5-431-050	Torch Body O-Ring	1
6.	EX-0-325-001	TCS Clam Shell Lower	1	16.	EX-5-304-030	Cap Sensor Replacement Kit with Screws /Machine Torch	1
7.	EX-0-325-010	Retaining Ring (Outer circlip ring)	1	17.	EX-5-317-021	Machine Torch Strain Relief	1
8.	EX-0-325-009	O-Ring (fitted in the TCS plug)	1	18.	EX-5-372-030	Pilot Cable Screw	1
9.	EX-0-325-005	Male Crimp Pin for TCS Plug	1	19.	EX-0-321-003	Latch w/Key Assembly	1

CONSUMABLES

MACHINE TORCH STANDARD CONSUMABLES - 45-85A

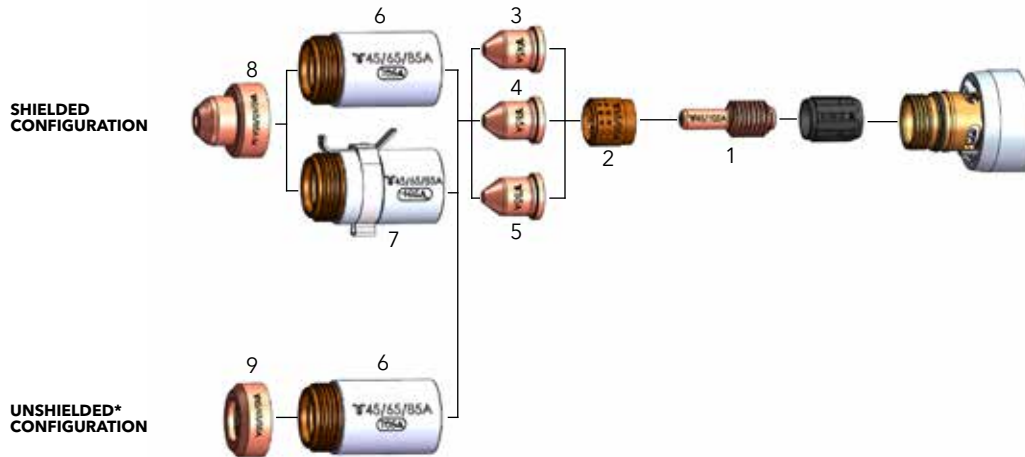

Item	Part No.	Description	Pcs	Item	Part No.	Description	Pcs
1.	EX-5-402-030	Electrode 45-105A (5pcs package) **	1x5	6.	EX-5-415-030	Retaining Cap 45-85A	1
2.	EX-5-404-031	Swirl Ring 45-85A	1	7.	EX-5-415-031	Retaining Cap 45-85A, IHS Tab	1
3.	EX-5-410-036	Nozzle 45A	5	8.	EX-5-421-031	Shield 45-85A, Machine	1
4.	EX-5-410-037	Nozzle 55/65A (5pcs package) **	1x5	9.	EX-5-423-031	Deflector 45-105A	1
5.	EX-5-410-038	Nozzle 75/85A (5pcs package) **	1x5				

* IN COUNTRIES FOLLOWING CE STANDARDS, UNSHIELDED CONSUMABLE CONFIGURATION MAY ONLY BE USED IN MECHANIZED TORCH APPLICATIONS.

** THIS PART IS AVAILABLE IN 5PCS SET ONLY

MACHINE TORCH STANDARD CONSUMABLES - 100/105A

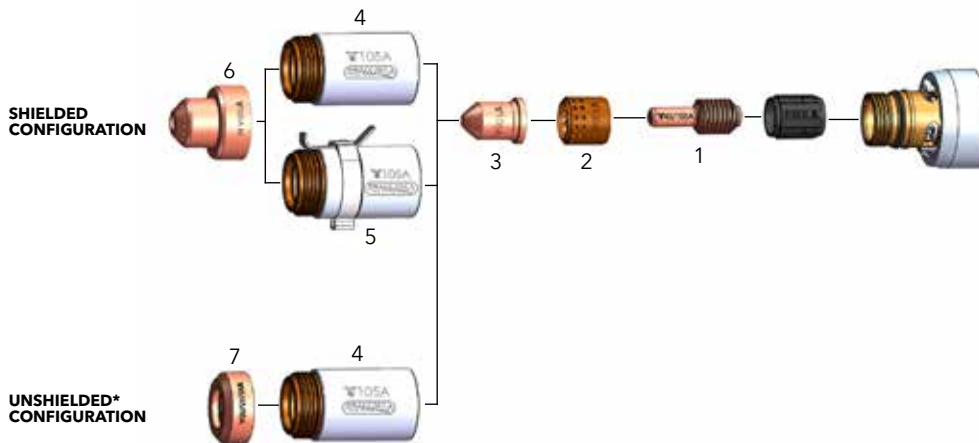

Item	Part No.	Description	Pcs	Item	Part No.	Description	Pcs
1.	EX-5-402-030	Electrode 45-105A (5pcs package) **	1x5	5.	EX-5-415-033	Retaining Cap 100/105A, IHS Tab	1
2.	EX-5-404-032	Swirl Ring 100/105A	1	6.	EX-5-422-030	Shield 100/105A, Machine	1
3.	EX-5-410-039	Nozzle 100/105A (5pcs package) **	1x5	7.	EX-5-423-031	Deflector 45-105A	1
4.	EX-5-415-032	Retaining Cap 100/105A	1				

* IN COUNTRIES FOLLOWING CE STANDARDS, UNSHIELDED CONSUMABLE CONFIGURATION MAY ONLY BE USED IN MECHANIZED TORCH APPLICATIONS.

** THIS PART IS AVAILABLE IN 5PCS SET ONLY

CONSUMABLES

MACHINE TORCH CONSUMABLES - FINELINE

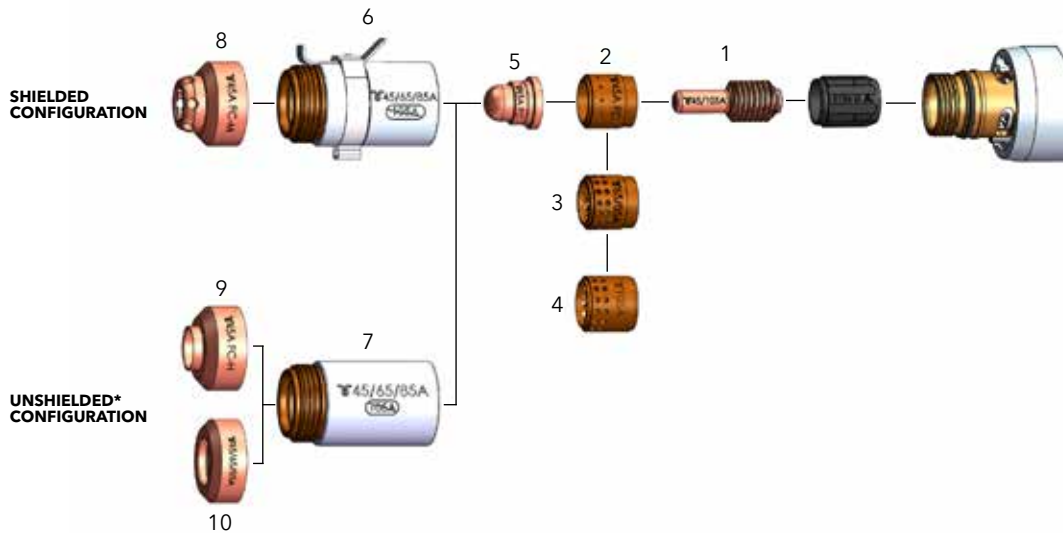

Item	Part No.	Description	Pcs	Item	Part No.	Description	Pcs
1.	EX-5-402-030	Electrode 45-105A (5pcs package) **	1x5	6.	EX-5-415-031	Retaining Cap 45-85A, IHS Tab	1
2.	EX-5-404-030	Swirl Ring 45-105A/FineLine	1	7.	EX-5-415-030	Retaining Cap 45-85A	1
3.	EX-5-404-031	Swirl Ring 45-85A	1	8.	EX-5-421-030	Shield 45A, IHS, FineLine	1
4.	EX-5-404-032	Swirl Ring 100/105A	1	9.	EX-5-423-030	Deflector 45A/ FineLine	1
5.	EX-5-410-035	Nozzle 45A/FineLine (5pcs package) **	1x5	10.	EX-5-423-031	Deflector 45-105A	1

* IN COUNTRIES FOLLOWING CE STANDARDS, UNSHIELDED CONSUMABLE CONFIGURATION MAY ONLY BE USED IN MECHANIZED TORCH APPLICATIONS.

** THIS PART IS AVAILABLE IN 5PCS SET ONLY

ACCESSORIES



Item	Part No.	Ref. No.	Description	Pcs	Item	Part No.	Ref. No.	Description	Pcs
1.	T-12452	EX-0-804-001	Filter-EX Compressed Air Filter	1	7.	EX-2-801-001	EX-2-801-001	Circle Cut. Guide Kit for FHT-EX*30/40H	1
2.	T-12453	EX-0-804-002	Filter-EX Air Filter Cartridge	8	7.	EX-5-801-002	EX-5-801-002	Circle cutting guide kit FHT-EX*105RTX/45TT	1
3.	EX-0-802-000	EX-0-802-000	Quick Connect Plug with female thread G 1/4"	1	8.	EX-0-806-001	EX-0-806-001	THERMACUT® Cutting Gloves	1
4.	EX-0-802-001	EX-0-802-001	Quick Connect Plug with male thread G 1/4"	1	9.	EX-0-803-001	EX-0-803-001	CNC Interface 14-pin Plug Kit	1
5.	EX-0-802-002	EX-0-802-002	Quick Connect Coupling with male thread G 1/4"	1	10.	EX-0-803-004	EX-0-803-004	CNC Interface connection lead 6m	1
6.	T-0994	EX-0-805-001	Silicone Lubricant 25ml	1					

Revision 1.07 - last update 21. 3. 2019

THINK FRESH. CUT ORANGE.

THERMACUT® comes up with fresh ideas for cutting technology.
Benefit from innovative, reliable, powerful and highly efficient cutting solutions.

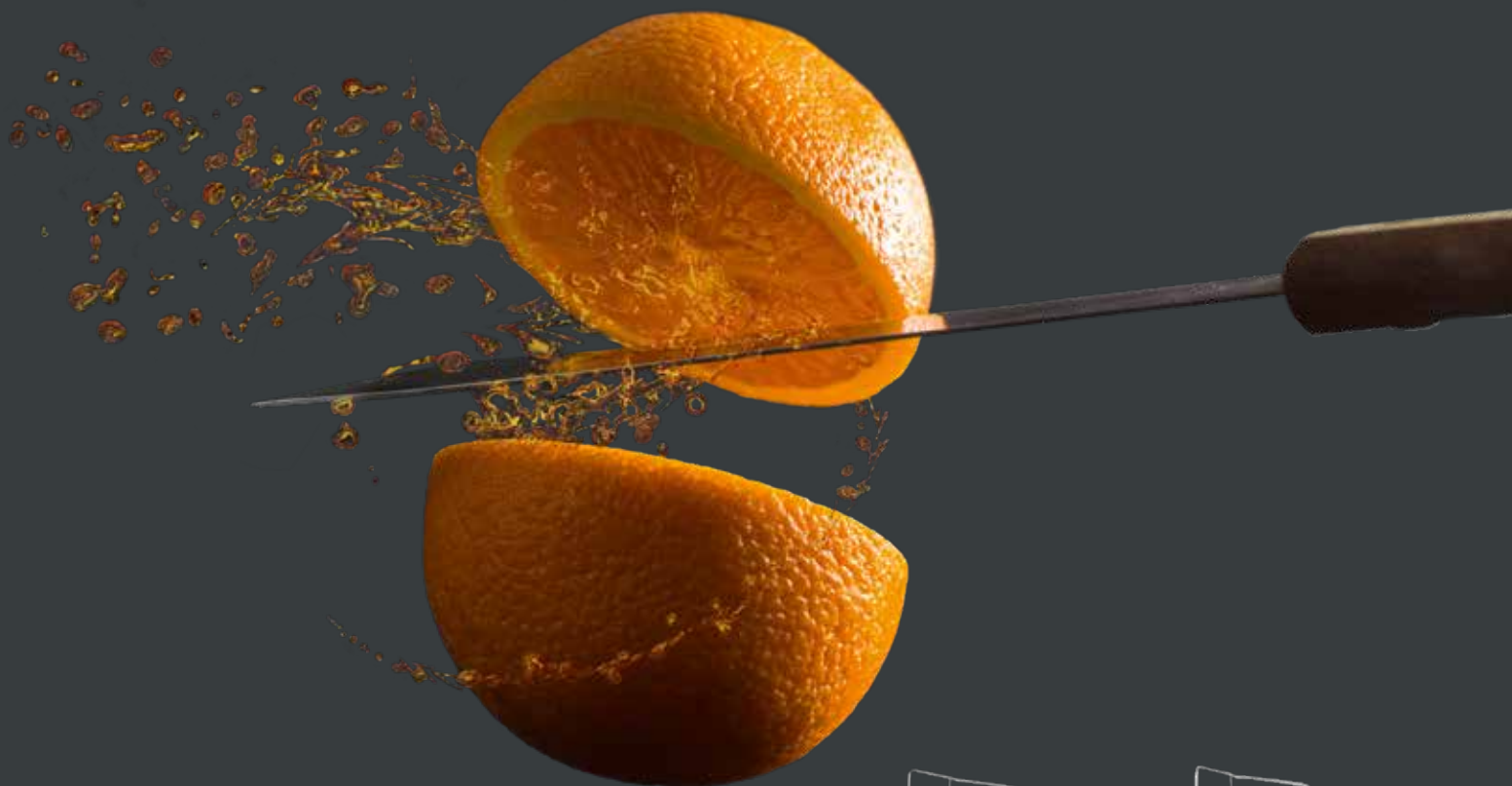

Discover the other plasma cutting systems within the EX-TRAFIRE® SD family and our wide range of cutting solutions at www.ex-trafire.com.

THERMACUT, k.s.
Sokolovská 574, Mařatice
68601 Uherské Hradiště
Czech Republic

sales@thermacut.cz
WWW.THERMACUT.COM

follow
#EXTRAFIRE

